

Honeywell

Installation Guide



FocusPRO™ TH5220D

Non-programmable Digital Thermostat



69-1783

Product Application

This thermostat provides electronic control of 24 VAC single-stage and multi-stage heating and cooling systems, or 750 mV heating systems.

System Types (up to 2 heat/2 cool)

- Gas, oil, or electric heat with air conditioning
- Warm air, hot water, high-efficiency furnaces, heat pumps, steam, gravity
- Heat only — two-wire systems, power to open and close zone valves (Series 20), and normally-open zone valves
- Heat only with fan
- Cool only
- 750 mV heating systems

Power Options

- Battery power only
- Common wire only
- Common wire with battery backup

Changeover Options

- Selectable manual or auto-changeover modes

System Settings

- Heat, Off, Cool, Auto, Em Heat

Fan Settings

- Auto, On

Must be installed by a trained, experienced technician

- Read these instructions carefully. Failure to follow these instructions can damage the product or cause a hazardous condition.
- Check the ratings in this booklet to verify that this product is suitable for your application (see page 17).
- Always test for proper operation after installation (see page 13).



CAUTION: ELECTRICAL HAZARD

Can cause electrical shock or equipment damage. Disconnect power before beginning installation.



MERCURY NOTICE

If this product is replacing a control that contains mercury in a sealed tube, do not place the old control in the trash. Contact your local waste management authority for instructions regarding recycling and proper disposal.

Table of contents

Installation

Pre-installation checklist2
Wallplate installation3
Wiring.....4
Wiring diagrams5
Power options10
Thermostat mounting10

Setup and testing

Installer setup.....11
Installer system test13
Explanation of features14

Appendices

Quick reference to controls.....15
Quick reference to display.....15
Battery replacement.....15
In case of difficulty16
Accessories/replacement parts17
Specifications17

Installation tips

Install the thermostat about 5 feet (1.5m) above the floor in an area with good air circulation at average temperature.

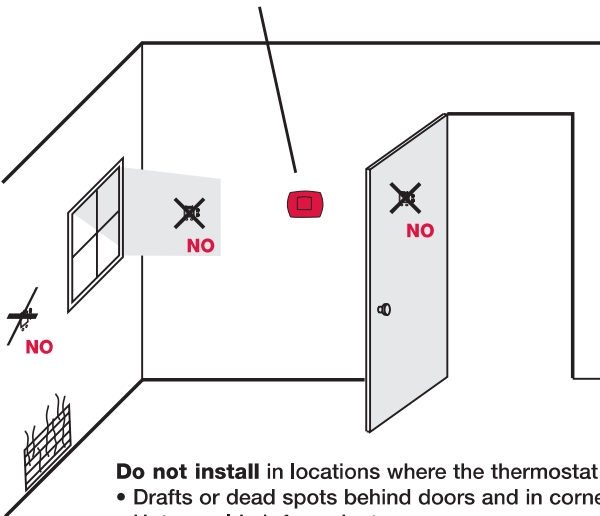

- Do not install** in locations where the thermostat can be affected by:
- Drafts or dead spots behind doors and in corners
 - Hot or cold air from ducts
 - Sunlight or radiant heat from appliances
 - Concealed pipes or chimneys
 - Unheated/uncooled areas such as an outside wall behind the thermostat

Pre-installation checklist

Package contents

Check to make sure your package includes the following items:

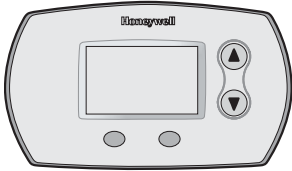

FocusPRO™ TH5220D
digital thermostat
(wallplate attached to back)



Operating manual



Wall anchors and
mounting screws
(2 each)



AA alkaline
batteries (2)

Required tools & supplies

- No. 2 Phillips screwdriver
- Small pocket screwdriver
- Drill
- Drill bit (3/16" for drywall, 7/32" for plaster)
- Hammer
- Pencil
- Electrical tape
- Level (optional)

Wallplate installation

Insert finger into wire hole and pull to remove wallplate from thermostat.

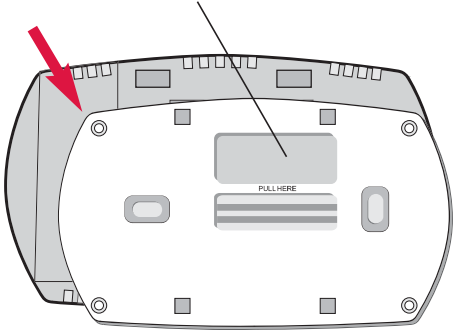

Remove the wallplate from the thermostat as shown at left, then follow directions below for mounting.

- 1 Pull wires through wire hole.
- 2 Position wallplate on wall, level and mark hole positions with pencil.
- 3 Drill holes at marked positions as shown below, then tap in supplied wall anchors.
- 4 Place wallplate over anchors, insert and tighten mounting screws.

Drill 3/16" holes for drywall.
Drill 7/32" holes for plaster.

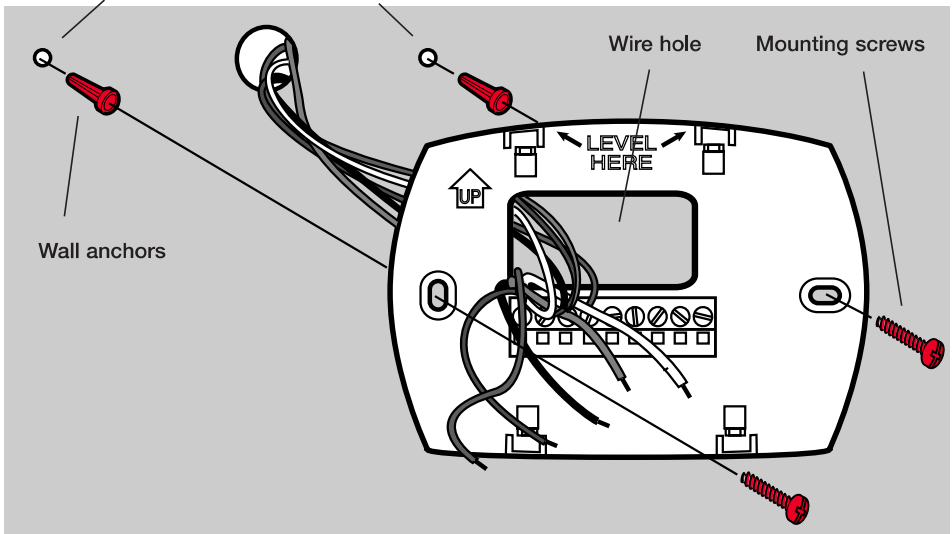

Wiring

CAUTION: ELECTRICAL HAZARD. Can cause electrical shock or equipment damage. Disconnect power before wiring.

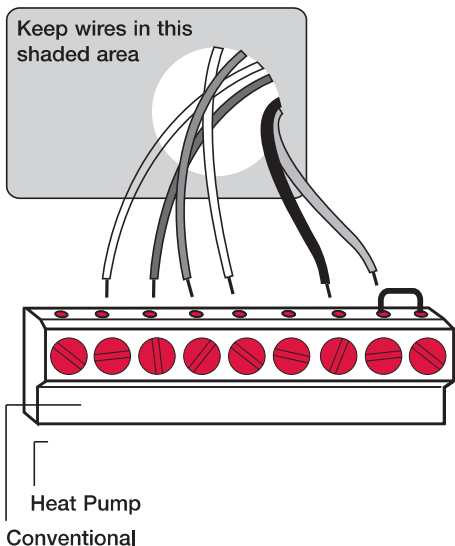

NOTES

R & Rc terminals

In single-transformer system, leave metal jumper in place between R & Rc. Remove metal jumper if two-transformer system.

C terminal

The C (common wire) terminal is optional when thermostat is powered by batteries.

W (O/B) terminal

If thermostat is configured for a heat pump in the Installer Setup, configure changeover valve for cool ("O" factory setting) or heat ("B").

L terminal (Output)

Heat pump reset. L terminal powered continuously when thermostat is set to Em Heat. Configure thermostat for 2 heat / 1 cool heat pump in the Installer Setup.

Wire specifications

Use 18- to 22-gauge thermostat wire. Shielded cable is not required.

Wiring

- 1 Loosen screw terminals, insert wires into terminal block, then re-tighten screws.
- 2 Push excess wire back into the wall opening. Keep wires in shaded area as shown at left.
- 3 Plug the wall opening with non-flammable insulation to prevent drafts from affecting thermostat operation.

Terminal Designations

Conventional Terminal Letters:

- Y2** 2nd stage compressor contactor
- W2** 2nd stage heat relay
- G** Fan relay
- W** 1st stage heat relay
- C** Common wire from secondary side of cooling system transformer
- Y** 1st stage compressor contactor
- R** Heating power. Connect to secondary side of heating system transformer.
- Rc** Cooling power. Connect to secondary side of cooling system transformer.

Heat Pump Terminal Letters:

- L** Heat pump reset. L terminal powered continuously when System is set to Em Heat.
- E** Emergency heat relay
- Aux** Auxiliary heat relay
- G** Fan relay
- O/B** Changeover valve for heat pumps
- C** Common wire from secondary side of cooling system transformer.
- Y** Compressor contactor
- R** Heating power. Connect to secondary side of heating system transformer.
- Rc** Cooling power. Connect to secondary side of cooling system transformer.

Wiring diagrams

- ▲ 1 Power supply. Provide disconnect means and overload protection as required.
- ▲ 2 Factory-installed jumper. Remove for 2-transformer systems only.
- ▲ 3 Optional 24VAC common connection.
- ▲ 4 In Installer Setup, set system type to **Heat Only**.
- ▲ 5 In Installer Setup, set system type to **1Heat/1Cool Heat Pump** & changeover valve to **0** or **B**.
- ▲ 6 In Installer Setup, set system type to **2Heat/1Cool Heat Pump**.
- ▲ 7 L terminal is powered continuously when thermostat is set to Em Heat.
- ▲ 8 Install field jumper between Aux and E if there is no emergency heat relay.
- ▲ 9 In Installer Setup, set system type to **2Heat/2Cool conventional**.

Typical 1H/1C system: 1 transformer

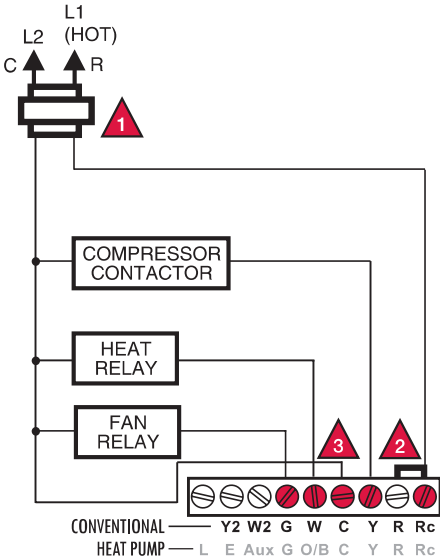

Typical 1H/1C system: 2 transformers

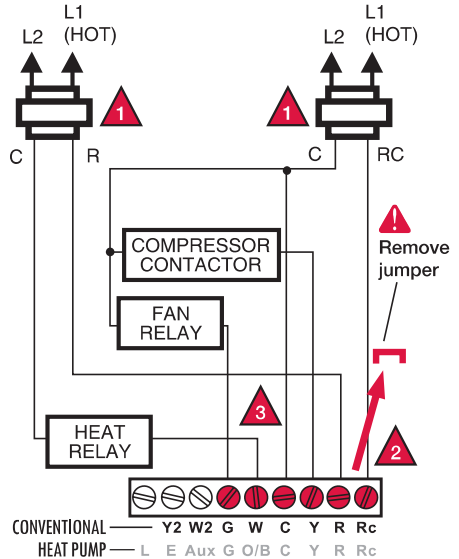

Wiring diagrams

- ▲ 1 Power supply. Provide disconnect means and overload protection as required.
- ▲ 2 Factory-installed jumper. Remove for 2-transformer systems only.
- ▲ 3 Optional 24VAC common connection.
- ▲ 4 In Installer Setup, set system type to **Heat Only**.
- ▲ 5 In Installer Setup, set system type to **1Heat/1Cool Heat Pump** & changeover valve to **0** or **B**.
- ▲ 6 In Installer Setup, set system type to **2Heat/1Cool Heat Pump**.
- ▲ 7 L terminal is powered continuously when thermostat is set to Em Heat.
- ▲ 8 Install field jumper between Aux and E if there is no emergency heat relay.
- ▲ 9 In Installer Setup, set system type to **2Heat/2Cool conventional**.

Typical 1H/1C heat pump system

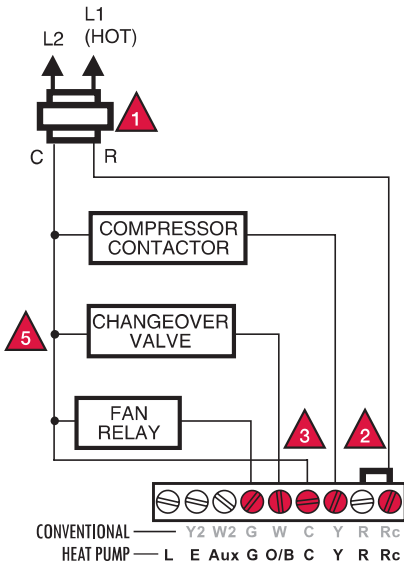

Typical heat-only system

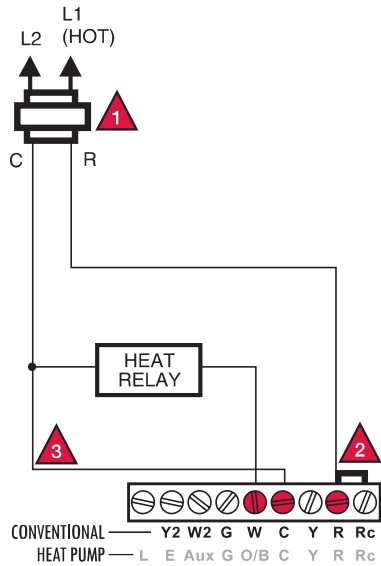

Wiring diagrams

- ▲ 1 Power supply. Provide disconnect means and overload protection as required.
- ▲ 2 Factory-installed jumper. Remove for 2-transformer systems only.
- ▲ 3 Optional 24VAC common connection.
- ▲ 4 In Installer Setup, set system type to **Heat Only**.
- ▲ 5 In Installer Setup, set system type to **1Heat/1Cool Heat Pump** & changeover valve to **0** or **B**.
- ▲ 6 In Installer Setup, set system type to **2Heat/1Cool Heat Pump**.
- ▲ 7 L terminal is powered continuously when thermostat is set to Em Heat.
- ▲ 8 Install field jumper between Aux and E if there is no emergency heat relay.
- ▲ 9 In Installer Setup, set system type to **2Heat/2Cool conventional**.

Typical heat-only system with fan

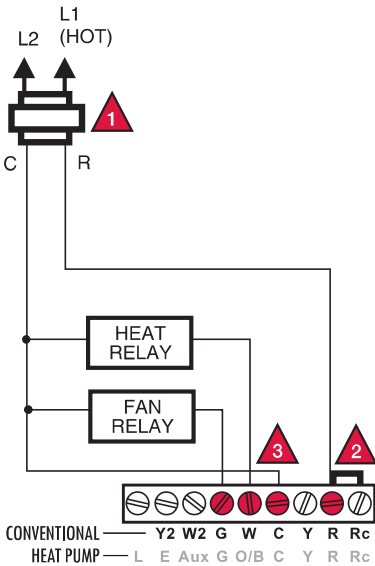

Heat-only system (Series 20)

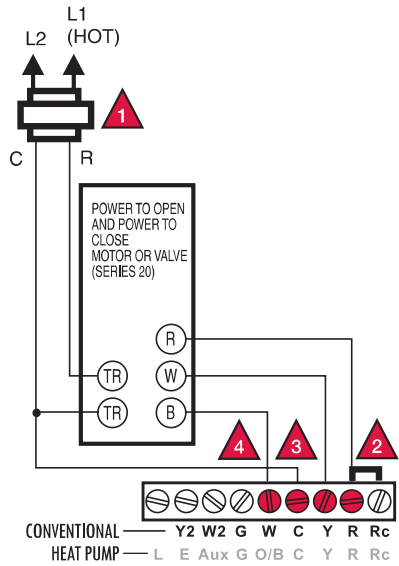

Wiring diagrams

- ▲1 Power supply. Provide disconnect means and overload protection as required.
- ▲2 Factory-installed jumper. Remove for 2-transformer systems only.
- ▲3 Optional 24VAC common connection.
- ▲4 In Installer Setup, set system type to **Heat Only**.
- ▲5 In Installer Setup, set system type to **1Heat/1Cool Heat Pump** & changeover valve to **0** or **B**.
- ▲6 In Installer Setup, set system type to **2Heat/1Cool Heat Pump**.
- ▲7 L terminal is powered continuously when thermostat is set to Em Heat.
- ▲8 Install field jumper between Aux and E if there is no emergency heat relay.
- ▲9 In Installer Setup, set system type to **2Heat/2Cool conventional**.

Typical cool-only system

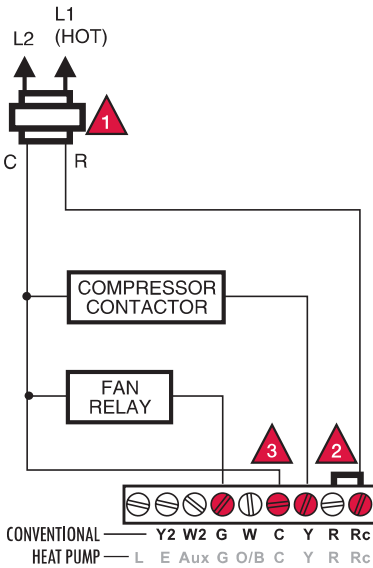

Heat-only system (normally open zone valve)

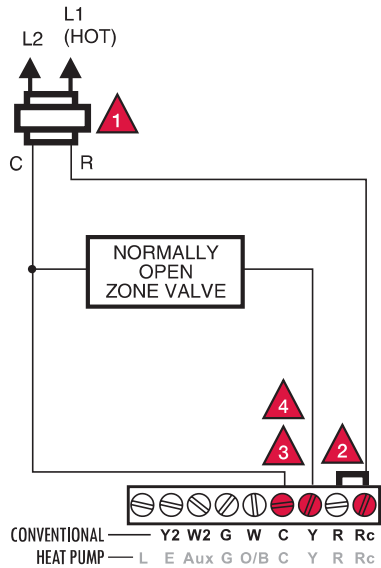

Wiring diagrams

- ▲ 1 Power supply. Provide disconnect means and overload protection as required.
- ▲ 2 Factory-installed jumper. Remove for 2-transformer systems only.
- ▲ 3 Optional 24VAC common connection.
- ▲ 4 In Installer Setup, set system type to **Heat Only**.
- ▲ 5 In Installer Setup, set system type to **1Heat/1Cool Heat Pump** & changeover valve to **0** or **B**.
- ▲ 6 In Installer Setup, set system type to **2Heat/1Cool Heat Pump**.
- ▲ 7 L terminal is powered continuously when thermostat is set to Em Heat.
- ▲ 8 Install field jumper between Aux and E if there is no emergency heat relay.
- ▲ 9 In Installer Setup, set system type to **2Heat/2Cool conventional**.

Typical 2H/2C system (1 transformer)

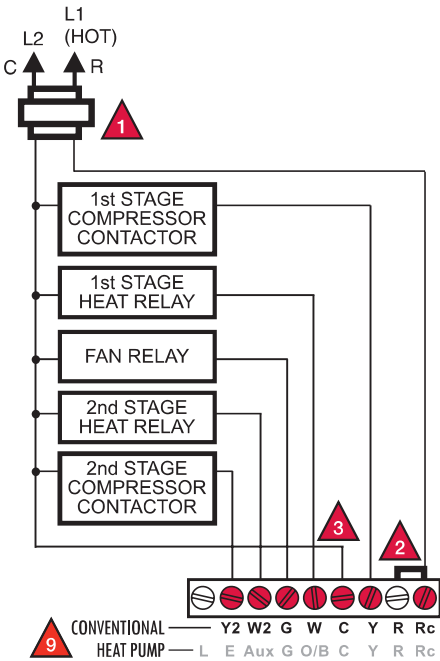

Typical 2H/1C heat pump system

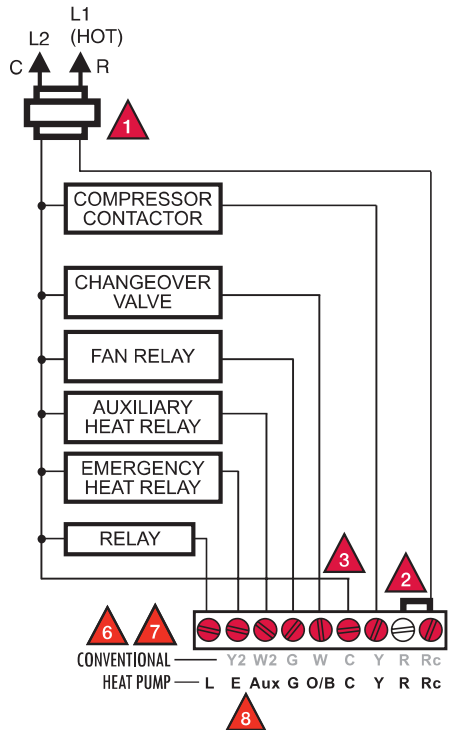

Power options & mounting

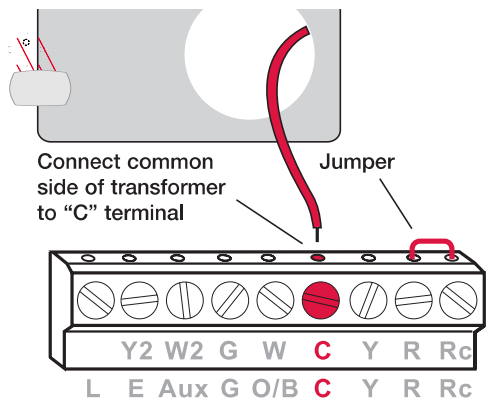

AC Power

The thermostat can be powered by 24 VAC power, or by batteries.

To wire the thermostat for AC power, connect the common side of the cooling transformer to the "C" terminal as shown at left.

Important: Remove R/Rc jumper for 2-transformer systems only. (See wiring diagram on page 5.)

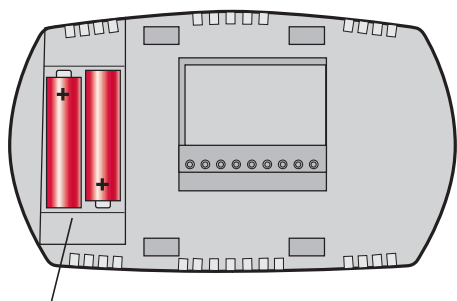

Install batteries in back of thermostat (optional if AC powered).

Battery Power

The thermostat can be powered by batteries alone or, if used with AC power, can provide backup power to the display during power interruptions.

After installation, batteries can be changed without removing the thermostat from the wall (see page 15).

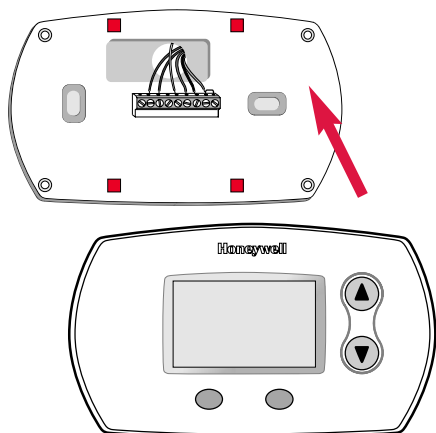

To Mount Thermostat

Align the 4 tabs on the wallplate with corresponding slots on the back of the thermostat, then push gently until the thermostat snaps in place.

Installer setup

Follow the procedure below to configure the thermostat to match the installed heating/cooling system, and customize feature operation as desired.

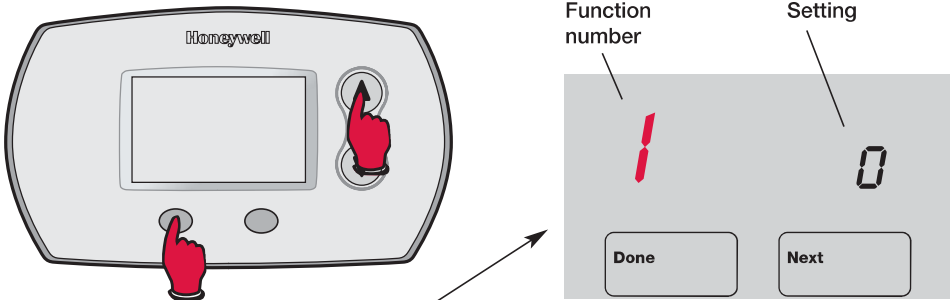

To begin, **press and hold** the ▲ and **FAN** buttons until the display changes

Press ▲ or ▼ to change settings
 Press **NEXT** to advance to next function
 Press **DONE** to exit and save settings

Setup Function

Settings & Options

- | | |
|--|---|
| <p>1 System type</p> | <p>0 Gas, oil or electric heat with air conditioning
 1 1 heat/1 cool heat pump
 2 Heat only (2-wire systems/power to open & close zone valves/ normally open zone valves)
 3 Heat only with fan
 4 Cool only
 5 2 heat/1 cool heat pump
 6 2 heat/2 cool conventional
 7 2 heat/1 cool conventional
 8 1 heat/2 cool conventional</p> |
| <p>2 Changeover valve (O/B terminal)</p> | <p>0 Changeover valve (O/B terminal energized in cooling)
 1 Changeover valve (O/B terminal energized in heating)</p> |
| <p>3 Fan control (heating)</p> | <p>0 Gas or oil furnace — equipment controls fan in heating
 1 Electric furnace — thermostat controls fan in heating</p> |
| <p>5 Heat cycle rate (CPH: cycles/hour)</p> | <p>5 For gas or oil furnaces of less than 90% efficiency
 1 For steam or gravity systems
 3 For hot water systems & furnaces of over 90% efficiency
 9 For electric furnaces
 [Other cycle rate options: 2, 4, 6, 7, 8, 10, 11 or 12 CPH]</p> |
| <p>6 Second stage heat cycle rate/ Auxiliary heat (CPH)</p> | <p>5 For gas or oil furnaces of less than 90% efficiency
 1 For steam or gravity systems
 3 For hot water systems & furnaces of over 90% efficiency
 9 For electric furnaces
 [Other cycle rate options: 2, 4, 6, 7, 8, 10, 11 or 12 CPH]</p> |

Continued on next page >

Installer setup

Follow the procedure below to configure the thermostat to match the installed heating/cooling system, and customize feature operation as desired.

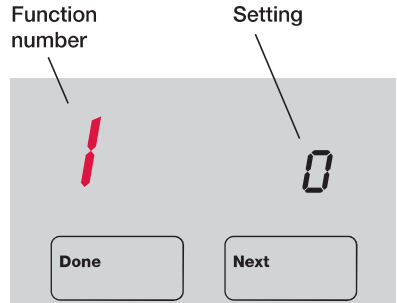
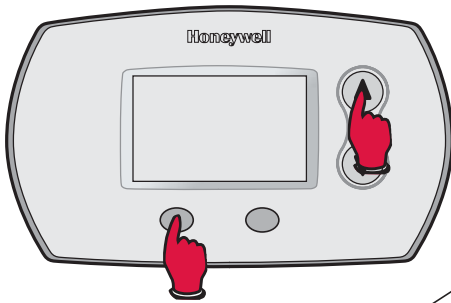

To begin, **press and hold** the ▲ and FAN buttons until the display changes

Press ▲ or ▼ to change settings
Press **NEXT** to advance to next function
Press **DONE** to exit and save settings

Setup Function

Settings & Options

- | | |
|--|---|
| 8 Emergency heat cycle rate (CPH) | 9 For electric emergency heat
1 For steam or gravity systems
3 For hot water systems & furnaces of over 90% efficiency
5 For gas or oil furnaces of less than 90% efficiency
[Other cycle rate options: 2, 4, 6, 7, 8, 10, 11 or 12 CPH] |
| 9 Compressor cycle rate (CPH) | 3 Recommended for most compressors
[Other cycle rate options: 1, 2, 4, 5 or 6 CPH] |
| 10 Second stage compressor cycle rate (CPH) | 3 Recommended for most compressors
[Other cycle rate options: 1, 2, 4, 5 or 6 CPH] |
| 12 System setting adjustment | 0 Manual changeover (Heat/Cool/Off)
1 Auto changeover (Heat/Cool/Auto/Off) **See page 14
2 Auto changeover only (Auto) **See page 14 |
| 14 Temperature display | 0 Fahrenheit
1 Celsius |
| 15 Compressor protection | 5 Five-minute compressor off time **See page 14
[Other options: 0, 1, 2, 3 or 4-minute off time] |
| 26 Auxiliary heat control | 0 Comfort **See page 14
1 Economy |
| 27 Heat temperature range stops | 90 Highest heating temperature setting
40-89 Heating temperature range (increments of 1°F, or 0.5°C) |
| 28 Cool temperature range stops | 50 Lowest cooling temperature setting
51-99 Cooling temperature range (increments of 1°F, or 0.5°C) |

Installer system test

Follow the procedure below to test the heating, cooling and fan.

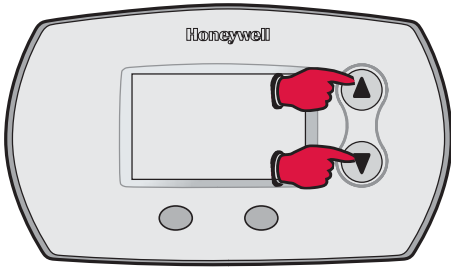

To begin, **press and hold** the ▲ and ▼ buttons until the display changes

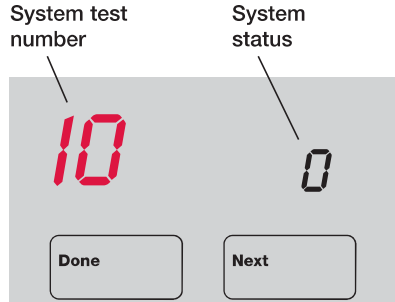

- Press ▲ to turn on system
- Press ▼ to turn off system
- Press **NEXT** to advance to next test
- Press **DONE** to terminate system test

System Test

System Status

10 Heating system	0 Heat and fan turn off 1 Heat turns on. Fan also turns on immediately if Function 1 is set to "1" or "5," or if Function 3 is set to "1" **See page 11 2 Second stage heat turns on
20 Emergency heating system	0 Heat and fan turn off 1 Heat and fan turn on 2 Second stage heat turns on (Aux)
30 Cooling system	0 Compressor and fan turn off 1 Compressor and fan turn on 2 Second stage compressor turns on
40 Fan system	0 Fan turns off 1 Fan turns on
70 Thermostat information (for reference only)	71 Software revision number (major revisions) 72 Software revision number (minor revisions) 73 Configuration identification code (major) 74 Configuration identification code (minor) 75 Production configuration date code (week) 76 Production configuration date code (year)



CAUTION: EQUIPMENT DAMAGE HAZARD

Compressor protection (minimum off time) is bypassed during testing. To prevent equipment damage, avoid cycling the compressor quickly.

Auto changeover (Setup Function 12)



Auto Changeover is a feature used in climates where both air conditioning and heating are used on the same day. When the system is set to Auto, the thermostat automatically selects heating or cooling depending on the indoor temperature.

Heat and cool settings must be at least 3 degrees apart. The thermostat will automatically adjust settings to maintain this 3-degree separation (called “deadband”).

The 3-degree separation between heating and cooling set temperatures is fixed, and cannot be changed.

Built-in compressor protection (Setup Function 15)

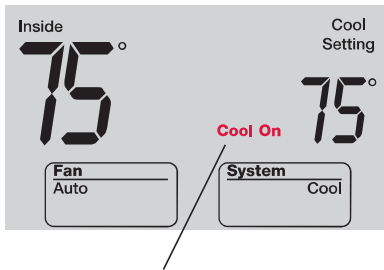

Message flashes until safe restart time has elapsed

This feature helps prevent damage to the compressor in your air conditioning or heat pump system.

Damage can occur if the compressor is restarted too soon after shutdown. This feature forces the compressor to wait for a few minutes before restarting.

During the wait time, the message Cool On or Heat On (heat pumps only) will flash on the display. When the safe wait time has elapsed, the message stops flashing and the compressor turns on.

Auxiliary heat control (Setup Function 26)

Systems with heat pumps can be set to operate in one of two ways:

Comfort Setting: The thermostat will prioritize comfort over economy depending on heat pump performance, load conditions and whether the equipment is calling for heat. Raising the temperature just a few degrees will often activate auxiliary heat.

Economy Setting: The thermostat will attempt to reach the temperature setting without activating auxiliary heat. The thermostat waits a preset time before allowing auxiliary heat to be activated depending on the compressor stage performance, and on how many degrees the temperature setpoint is changed.

Quick reference to controls

Digital display screen

Battery holder (see page 10)

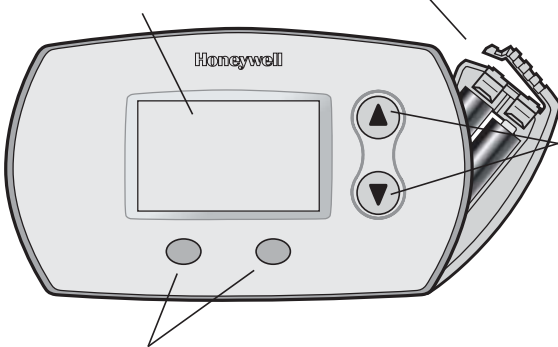

Temperature buttons
Press to adjust temperature settings

Function buttons

Press to select the function displayed just above each button.
(Functions change depending on the task.)

Quick reference to display screen

A diagram of the thermostat's digital display screen. The screen is divided into several sections. On the left, it shows 'Inside' temperature as '75°'. In the center, there is a 'Replace Battery' warning. On the right, it shows 'Heat Setting' as '75°'. Below the temperature readings are two boxes: 'Fan Auto' and 'System Heat'. At the bottom of the screen are two red circular function buttons. Labels with arrows point to various elements: 'Low battery warning' points to the 'Replace Battery' text; 'Auxiliary heat (Only for heat pumps with auxiliary heat)' points to the 'Auxiliary Heat On' text; 'Temperature setting' points to the 'Heat Setting' value; 'System status Heat On/Cool On (If flashing, see page 14)' points to the 'System Heat' box; 'System setting Heat/Cool/Auto/Off/Em Heat' points to the 'System Heat' box; 'Current inside temperature' points to the '75°' value; 'Fan setting Auto/On' points to the 'Fan Auto' box; and 'Function buttons' points to the two red buttons at the bottom.

Battery replacement

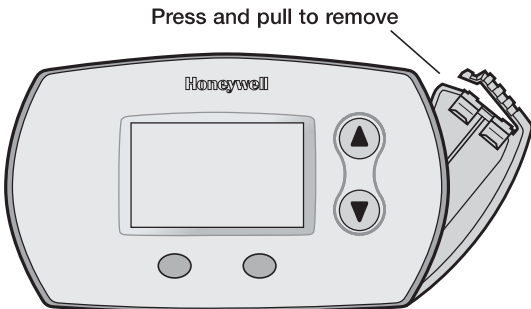

Insert fresh AA alkaline batteries, then reinstall battery holder

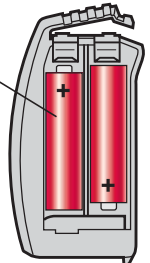

In case of difficulty

If you have difficulty with your thermostat, please try the suggestions below. Most problems can be corrected quickly and easily.

- Display is blank**
- Check circuit breaker and reset if necessary.
 - Make sure power switch at heating & cooling system is on.
 - Make sure furnace door is closed securely.
 - If thermostat is battery powered, make sure fresh AA alkaline batteries are correctly installed (see page 10).
- Temperature settings do not change**
- Make sure heating and cooling temperatures are set to acceptable ranges:
- Heat: 40° to 90°F (4.5° to 32°C).
 - Cool: 50° to 99°F (10° to 37°C).
- Check temperature range stop settings (Function 27 & 28 on page 12).
- Heating system does not respond (“Heat On” appears on screen)**
- Check for 24 Vac at the equipment on the secondary side of the transformer between power and common. If voltage is not present, check the heating equipment to find the cause of the problem.
 - Check for 24 Vac between the heat terminal (W) and the transformer common. If 24 Vac is present, the thermostat is functional. Check the heating equipment to find the cause of the problem.
 - Check for loose or broken wires between the thermostat and the heating equipment.
- Cooling system does not respond (“Cool On” appears on screen)**
- Check for 24 Vac at the equipment on the secondary side of the transformer between power and common. If voltage is not present, check the cooling equipment to find the cause of the problem.
 - Check for 24 Vac between the cooling terminal (Y) and the transformer common. If 24 Vac is present, the thermostat is functional. Check the cooling system to find the cause of the problem.
 - Check for loose or broken wires between the thermostat and the cooling equipment.
- Fan does not turn on in a call for heat**
- Check Installer Setup, Function 3 (Fan Control), to make sure the fan control is properly set to match the type of system (see page 11).
- Heat pump issues cool air in heat mode, or warm air in cool mode**
- Check Installer Setup, Function 2 (Changeover Valve), to make sure it is properly configured for your system (see page 11).
- Heat/cool both on at same time, or heat does not turn off**
- Check Installer Setup, Function 1 (System Type), to make sure it is set to match the installed heating/cooling equipment (see page 11).
 - Check to make sure heating and cooling wires are not shorted together.

In case of difficulty

- Heating equipment is running in cool mode**
 - Check Installer Setup, Function 1 (System Type), to make sure it is set to match the installed heating/cooling equipment (see page 11).

- Cannot change system setting to “Heat”**
 - Check Installer Setup, Function 1 (System Type), to make sure it is set to match the installed heating equipment (see page 11).
 - Change Installer Setup, Function 12 (System Setting) to Manual or Auto Changeover (see page 12).

- Cannot change system setting to “Cool”**
 - Check Installer Setup, Function 1 (System Type), to make sure it is set to match the installed cooling equipment (see page 11).
 - Change Installer Setup, Function 12 (System Setting) to Manual or Auto Changeover (see page 12).

- “Heat On” is not displayed**
 - Change the System Setting to Heat, and set the temperature level above the current room temperature.

- “Cool On” is not displayed**
 - Change the System Setting to Cool, and set the temperature level below the current room temperature.

- “Cool On” or “Heat On” is flashing**
 - Compressor protection timeout is engaged. Wait 5 minutes for the system to restart safely, without damage to the compressor.

Accessories & replacement parts

Please contact your distributor to order replacement parts.

- Battery holder**Part Number 50007072-001
 - Cover plate assembly**Part Number 50002883-001
- (Use to cover marks left by old thermostats.)

Specifications

Temperature Ranges	Electrical Ratings		
<ul style="list-style-type: none"> • Heat: 40° to 90°F (4,5° to 32°C) • Cool: 50° to 99°F (10° to 37°C) 	Terminal	Voltage (50/60Hz)	Running Current
Operating Ambient Temperature	W (O/B) Heating	20-30 Vac	0.02-1.0 A
<ul style="list-style-type: none"> • 32° to 120°F (0° to 48.9°C) 	(Powerpile)	750 mV DC	100 mA DC
Shipping Temperature	W2 (Aux) Heating	20-30 Vac	0.02-0.5 A
<ul style="list-style-type: none"> • -20° to 120°F (-28.9° to 48.9°C) 	Y Cooling	20-30 Vac	0.02-1.0 A
Operating Relative Humidity	Y2 Cooling	20-30 Vac	0.02-1.0 A
<ul style="list-style-type: none"> • 5% to 90% (non-condensing) 	G Fan	20-30 Vac	0.02-0.5 A
Physical Dimensions	E Emergency heat	20-30 Vac	0.02-1.0 A
<ul style="list-style-type: none"> • 3-9/16” H x 5-13/16” W x 1-1/2” D • 91 mm H x 147 mm W x 38 mm D 	L Heat pump reset	20-30 Vac	0.02-0.5 A