



BRADFORD WHITE[®]
W A T E R H E A T E R S

TTW[®] Eco-Defender
Residential Ultra Low NO_x Gas Water Heaters

SERVICE MANUAL

Troubleshooting Guide
and Instructions for Service

(To be performed ONLY by
qualified service providers)

Models Covered by This Manual:

U1TW40S*FRN
U1TW50S*FRN
U1TW60T*FRN
U4TW40T*FRN
U4TW50T*FRN
U4TW60T*FRN
U2TW50T*FRN
U2TW65T*FRN
UTW450S60FR*N
UTW465S60FR*N

(* Denotes Warranty Years)



Eco-DEFENDER
SAFETY SYSTEM[®] WITH SCREENLOK[®] TECHNOLOGY
ULTRA LOW NO_x SERIES

(Model Shown: U-4-TW-40T6FRN)

Table of Contents

<u>Section</u>	<u>Page</u>
Introduction _____	5
How to Use this Manual _____	6
Tools Required for Service _____	7
Specifications _____	8
Sequence of Operation _____	12
Power Up Sequence	
Normal Heating Sequence	
Abnormal Operation	
Troubleshooting _____	17
Burner Maintenance _____	20
Burner Inspection	
Burner Cleaning Procedure	
Pilot Maintenance _____	22
Pilot Inspection Testing and Replacement	
Pressure Switch Testing and Replacement _____	25
Blower Testing and Replacement _____	28
Blower Temperature Switch Testing and Replacement _____	31
Thermal Well Testing _____	34
Determine Water Temperature Inside Tank _____	35
Gas Control and Thermal Well Testing and Replacement _____	36
Flammable Vapor Sensor Testing and Replacement _____	40
115 VAC Circuit Trace _____	40
Safety Circuit Voltage Trace _____	42
Flue Baffle Inspection and Replacement _____	43
Diptube Inspection and Replacement _____	44
Anode Inspection and Replacement _____	45
Inner Door Removal, Inspection and Replacement _____	46
Inner Door Gasket Replacement _____	47
Inner Door Installation _____	48
ScreenLok ® Flame Arrestor Cleaning _____	49
Common Terms _____	50
Notes _____	50
Parts List _____	51



WARNING

If the information in these instructions is not followed exactly, a fire or explosion may result causing property damage, personal injury, or death.

What to do if you smell gas:

- Do not try to light any appliance
- Do not touch any electrical switch; do not use any phone in your building
- Immediately call your gas supplier from a neighbor's phone. Follow the gas supplier's instructions.
- If you cannot reach your gas supplier, call the fire department.

Installation and service must be performed by a qualified installer, service agency, or the gas supplier.



DANGER

Do not store or use gasoline or other flammable, combustible, or corrosive vapors and liquids in the vicinity of this or any other appliance.



CAUTION

Incorrect operation of this water heater may create a hazard to life and property and will nullify the warranty.

If sweat fittings are to be used, DO NOT apply heat to the nipples on top of the water heater. Sweat the tubing to the adapter before fitting the adapter to the water connections. It is imperative that heat is not applied to the nipples containing a plastic liner.

Turn off or disconnect the electrical power supply to the water heater before servicing. Label all wires prior to disconnection when servicing controls. Wiring errors can cause improper and dangerous operation. Verify proper operation after servicing.

NOTICE

Before proceeding, please inspect the water heater and its components for possible damage. DO NOT install any water heater with damaged components. If damage is evident, then please contact the supplier where the water heater was purchased or the manufacturer listed on the rating plate for replacement parts.

 **WARNING**

Water heaters are heat producing appliances. To avoid damage or injury, do not store materials against the water heater or any of its components. Use proper care to avoid unnecessary contact, especially by children, with the water heater and its components. Under no circumstances must flammable materials, such as gasoline or paint thinner be used or stored in the vicinity of this water heater or in any location in which the fumes could reach the water heater.

Hydrogen gas can be produced in an operating water heater that has not had water drawn from the tank for a long period of time (generally two weeks or more). Hydrogen gas is extremely flammable. To prevent the possibility of injury under these conditions, we recommend a hot water faucet to be open for several minutes at the kitchen sink before you use any electrical appliance which is connected to the hot water system. If hydrogen is present, there will be an unusual sound such as air escaping through the pipes as hot water begins to flow. Do not smoke or have open flame near the faucet at the time it is open.

DO NOT ATTEMPT TO LIGHT ANY GAS APPLIANCE IF YOU ARE NOT CERTAIN OF THE FOLLOWING:

Liquefied petroleum gases/propane gas and natural gas have an odorant added by the gas supplier that aids in the detection of the gas. Most people recognize this odor as a "sulfur" or "rotten egg" smell. Other conditions, such as "odorant fade" can cause the odorant to diminish in intensity, or "fade," and not be as readily detectable. If you have a diminished sense of smell, or are in any way unsure of the presence of gas, immediately contact your gas supplier from a neighbor's telephone. Gas detectors are available. Contact your gas supplier, or plumbing professional for more information.

FAILURE TO INSTALL AND MAINTAIN A NEW, LISTED 3/4" X 3/4" TEMPERATURE AND PRESSURE RELIEF VALVE WILL RELEASE THE MANUFACTURER FROM ANY CLAIM THAT MIGHT RESULT FROM EXCESSIVE TEMPERATURE AND PRESSURES.

The Bradford White ECO-DEFENDER Safety System[®]

The Bradford White ECO-DEFENDER Safety System was designed to resist the ignition of flammable vapors that can occur outside of the water heater and produce Ultra Low NOx emissions. Use and installation are nearly identical to previous versions of atmospherically fired and vented water heaters. A number of exclusive design features are incorporated in the system that will require additional knowledge on the part of the qualified service provider. The following information will instruct service professionals on the function, proper diagnosis, and repair of water heaters employing the Bradford White ECO-DEFENDER Safety System.

Introduction

The new Bradford White TTW ECO-DEFENDER water heaters are designed to provide reliable performance with enhanced standard features. New design features include reliable spark to pilot ignition system, enhanced diagnostics, simplified servicing, quiet operation, additional vent lengths, Bradford White ECO-DEFENDER Safety System[®] and Ultra Low NOx emissions.

Spark-to-Pilot Ignition System - Employing the spark-to-pilot ignition system promotes reliable and consistent pilot and main burner ignitions to provide hot water on demand.

Integrated Immersion Thermal Well/Gas Control with LED - Was developed for ease of troubleshooting by providing simple diagnostic codes to pinpoint an installation or component performance issue.

New Powerful Blower - Will eliminate problems with difficult venting situations.

Quieter and Cooler Blower Operation - Blower noise is significantly reduced for both interior and exterior environments. Cooler operation increases blower life by reducing bearing wear and noise.

Rugged Wiring Connections - receptacle type connections promote error free wiring.

Increased Vent Lengths - Increased venting performance is achieved while maintaining Energy Factor and FHSR performance.

The TTW1 (U1TW & U4TW), TTW2 (U2TW) & UTW4 water heaters use a combustion system where flue gases are combined with dilution air to reduce the flue gas temperature in the blower. The diluted flue gases are evacuated to the exterior through low temperature vent materials. The gas control maintains water temperature, ignition sequence and regulates gas flow. A safety circuit consisting of a pressure switch and blower temperature switch verifies proper conditions exist for safe and reliable operation. If a situation outside of normal

How to Use this Manual

operating parameters exists, the gas control diagnostic LED will flash a code to positively identify an operational issue.

This service manual is designed to facilitate problem diagnosis and enhance service efficiency. To further promote quicker service times the new gas valve can be removed and replaced without draining the water heater. A special tool is required and will be provided with each gas valve kit shipped from our Service Parts department.

Please read the service manual completely before attempting service on this new series of power

How the Safety System Works

During normal operation, most air for combustion is drawn into the water heater through the openings in the jacket door. This air travels into the burner venturi, mixing with the gas jet. This air is then mixed with gas inside the burner and drawn to the burner screen and is efficiently combusted producing Ultra Low NOx emissions. Additional air is drawn through the openings in the jacket. This air travels down and around the combustion chamber and enters through holes in the bottom of the corrosion-resistant combustion chamber. The air then travels up through the oriented flame arrestor plate louvers, where the velocity of the air is increased and its direction altered. The air then mixes in a normal manner with the combustion products from the burner.

In the case where trace amounts of flammable vapors are present in the air flowing into the combustion chamber and burner venturi, the vapors are harmlessly ignited by the burner / pilot flame. If flammable vapors are in sufficient quantity to prevent normal combustion, the burner and pilot flames are designed to shut down.

Should the flammable vapors continue to the burner, the flame arrestor plate and burner screen prevent the flames from traveling backwards and igniting vapors outside of the combustion chamber. This causes the thermopile to overheat and shuts down the main pilot and burner. The thermopile powers the intelligent diagnostic control which is capable of recognizing restricted airflow conditions caused by severe lint, dust and oil accumulation on the burner screen and arrestor plate. The intelligent diagnostic control will deactivate the burner and pilot in the unlikely event of restricted airflow.

How to Use this Manual

It is intended for this manual to be used by qualified service personnel for the primary purpose of troubleshooting and repair of the Bradford White Residential Flue Damper water heaters. Understanding the sequence of operation section of this manual will contribute greatly to troubleshooting the water heater.

The Honeywell WV4460E Electronic Gas Control will display error codes in the event of abnormal operation. Error codes are listed in the troubleshooting chart beginning on page 13 of this service manual. The troubleshooting chart will also indicate the probable cause for the error code and direct the service professional to a service procedure to properly diagnose the abnormal operation.

Contact the Bradford White technical support group immediately if diagnosis cannot be made using the methods described in this service manual.

Tools Required for Service

Manometer: A liquid “U” tube type or a digital (magna-helic) type can be used. This device is used to measure gas and/or air pressure and vacuum.

Multi-Meter: A digital type is strongly recommended. This device is used to measure electrical values. The meter you select must have the capability to measure volts AC, volts DC, amps, micro-amps and ohms.

Electronic Probes: In some cases, standard multi-meter probes will damage or simply not be effective to obtain certain voltage and ohm reading. It will be necessary to have special electronic “pin” type multi-meter probes. These probes are available at most electronic wholesale outlets.

Thermometer: Used to measure water temperature. An accurate thermometer is recommended.

Water Pressure Gage: Used to measure water supply pressure. Also used to determine tank pressure by adapting to the drain valve of the heater.

Gas Control Service Tool: BWC part number 239-45991-00. A specialized tool designed to remove the gas control from gas control thermal well. Available from your Bradford White parts supplier.

Various Hand Tools: Pipe wrench, channel locks, open end wrenches (3/8", 7/16", 1/2"), 12" crescent wrench, Allen wrench set, screw drivers (common & Phillips), 1/4" nut driver, pliers (common & needle nose), socket set, side cutters, wire cutters, wire strippers, wire crimpers, torpedo level, small shop vac, step ladder, flashlight, and 5 gallon pail.

Specifications

Power Supply	Dedicated 115VAC, 60 Hz, 15A.
Gas Supply Pipe	Minimum 1/2" NPT (schedule 40 black iron pipe recommended).
Approved Gas Type	Natural Gas.
Gas Pressure	6.0" W.C. minimum, 11.0" W.C. maximum.
Venting System	Power vent through the wall or vertical through the roof.
Approved Vent Materials	PVC, CPVC or ABS.
Minimum clearance for Servicing	18" from top, 24" from front, 4" sides and rear.
Water Supply Pressure	150 PSI maximum allowable working pressure. Check local codes for supply pressure.
TCO Limit	Residential 188°F (87°C), Commercial 199°F (93°C).
Residential Temperature Set Point Range	60°F (16°C) to 160°F (71°C) (approximate temperatures).
Commercial Temperature Set Point Range	80°F (27°C) to 180°F (82°C) (approximate temperatures).
Blower Temperature Switch	Normally closed, opens @ 165°F (74°C), auto reset @130°F (54°C)
Pressure Switch	<p>UTW1 Models: Normally open, closes on vacuum increase @ -0.68, opens on vacuum decrease @ -0.65</p> <p>U4TW Models: Normally open, closes on vacuum increase @ -0.83, opens on vacuum decrease @ -0.80</p> <p>U2TW & UTW4 Models: Normally open, closes on vacuum increase @ -1.28, opens on vacuum decrease @-1.25</p>
Blower	<p>U1TW & U4TW Models: 115VAC, 60Hz, 3.1 amps, 3000 RPM, 42 CFM @ 1.5" W.C.</p> <p>U2TW & UTW4 Models: 115VAC, 60Hz, 3.1 amps, 3000 RPM, 68 CFM @ 0.4" W.C.</p>

Vent Tables

Venting Specifications for:

40 Gallon

50 Gallon

60 Gallon

2" Diameter (5.1 cm) PVC Vent Connector Lengths			
Terminating	# of Elbows	Maximum Straight Length ft (m)	Minimum Straight Length ft (m)
Through the Wall	1	45 (13.7)	2 (0.6)
Through the Wall	2	40 (12.2)	2 (0.6)
Through the Wall	3	35 (10.7)	2 (0.6)
Through the Wall	4	30 (9.2)	2 (0.6)
Through the Roof	0	50 (15.2)	7 (2.1)
Through the Roof	1	45 (13.7)	7 (2.1)
Through the Roof	2	40 (12.2)	7 (2.1)
Through the Roof	3	35 (10.7)	7 (2.1)
Through the Roof	4	30 (9.2)	7 (2.1)

3" Diameter (7.6 cm) PVC Vent Connector Lengths			
Terminating	# of Elbows	Maximum Straight Length ft (m)	Minimum Straight Length ft (m)
Through the Wall	1	115 (35.0)	10 (3.1)
Through the Wall	2	110 (33.5)	10 (3.1)
Through the Wall	3	105 (32.0)	10 (3.1)
Through the Wall	4	100 (30.5)	10 (3.1)
Through the Wall	5	95 (29.0)	10 (3.1)
Through the Roof	0	120 (36.6)	15 (4.6)
Through the Roof	1	115 (35.0)	15 (4.6)
Through the Roof	2	110 (33.5)	15 (4.6)
Through the Roof	3	105 (32.0)	15 (4.6)
Through the Roof	4	100 (30.5)	15 (4.6)

Specifications

Vent Tables

Venting Specifications for:

48 Gallon

65 Gallon

3" Diameter (7.6 cm) PVC Vent Connector Lengths			
Terminating	# of Elbows	Maximum Straight Length ft (m)	Minimum Straight Length ft (m)
Through the Wall	1	55 (16.8)	2 (0.6)
Through the Wall	2	50 (15.2)	2 (0.6)
Through the Wall	3	45 (13.7)	2 (0.6)
Through the Wall	4	40 (12.2)	2 (0.6)
Through the Roof	0	60 (18.3)	7 (2.1)
Through the Roof	1	55 (16.8)	7 (2.1)
Through the Roof	2	50 (15.2)	7 (2.1)
Through the Roof	3	45 (13.7)	7 (2.1)

4" Diameter (10.2 cm) PVC Vent Connector Lengths			
Terminating	# of Elbows	Maximum Straight Length ft (m)	Minimum Straight Length ft (m)
Through the Wall	1	175 (53.3)	10 (3.1)
Through the Wall	2	170 (51.8)	10 (3.1)
Through the Wall	3	165 (50.3)	10 (3.1)
Through the Wall	4	160 (48.8)	10 (3.1)
Through the Wall	5	155 (47.2)	10 (3.1)
Through the Roof	0	180 (54.9)	15 (4.6)
Through the Roof	1	175 (53.3)	15 (4.6)
Through the Roof	2	170 (51.8)	15 (4.6)
Through the Roof	3	165 (50.3)	15 (4.6)
Through the Roof	4	160 (48.8)	15 (4.6)

Control Timings

Ignition State	Timing
Pre-purge	15 seconds
Trial for Ignition	90 seconds
Flame Stabilization Period	3 seconds
Inter-purge	15 seconds
Flame Failure Response Time	1.5 seconds (2 second maximum, 1 second minimum)
Post-purge	15 seconds
PS Fault Delay (failed open/close)	Retry after 2 minutes
Soft Lockout	Retry after 5 minutes
TCO Limit Lockout	Indefinite (see page 34 to reset)
Verify Resistive Delay	Retry after 2 minutes (repeats 5 times)
Simulated Resistive Load Lockout	Indefinite (cycle power to reset)
Hardware Error Lockout	Indefinite (self clears if fault clears for at least 15 seconds)

Wiring Diagram

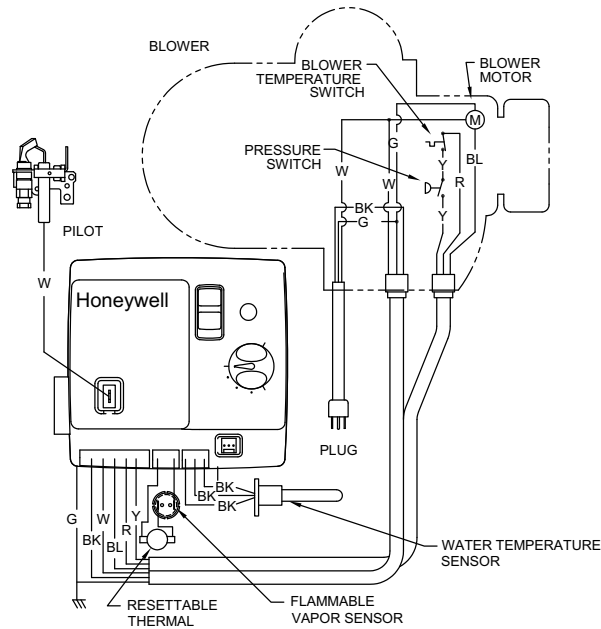

Sequence of Operation

Power Up Sequence

1. Start-up: Upon power up, the gas control runs a safe start check with a typical delay of 5 seconds.
2. Flammable Vapor Verification: The gas control verifies that the Flammable Vapor Sensor is in the proper operating range prior to energizing any components. If the sensor is within the proper range, the gas control resumes normal operation. If the Flammable Vapor Sensor is out of range, the gas control LED immediately flashes 7 times with a 3 second pause.

Normal Heating Sequence

1. Thermostat Calls for Heat: Prior to energizing the blower, the gas control checks the safety circuit to insure the circuit is open. In the safety circuit the pressure switch is normally open and the blower temperature switch is normally closed.
2. If the safety circuit is closed, the gas control waits 4 seconds, the gas control LED flashes 2 times with a 3 second pause. The gas control waits 2 minutes. Then, the blower runs for 30 seconds. This cycle repeats until the safety circuit opens.
3. Blower energizes.
4. Pressure switch proves blower/vent system operation: If the pressure switch does not close within 30 seconds, the gas control LED flashes 3 times with 3 second pause. The blower runs for 30 seconds every 2 minutes trying to get the pressure switch or blower temperature switch to close. This cycle repeats as long as there is a call for heat.
5. Blower pre-purge period (15 seconds).
6. Trial for Pilot Ignition (90 seconds): The gas control lights the pilot by activating the spark igniter and gas flow to the pilot burner. If flame is not sensed within 90 seconds, the spark igniter and gas flow are deactivated. The blower will post-purge, and the gas control LED flashes 6 times with a 3 second pause.

Normal Heating Sequence (cont'd)

7. Main Burner Ignition: After pilot flame is sensed, the gas control activates the main valve for main burner ignition. The gas control will ignore flame and pressure switch signals for 3 seconds to allow for the main burner to stabilize.

8. Steady State Operation: During steady state operation, the gas control monitors:

Thermostat Temperature Sensor: When the setpoint temperature is satisfied, the gas control is shutdown, and the blower will post-purge for 15 seconds. The gas control LED flashes a short flash once every 4 seconds (Idle status code).

Pressure switch/blower temperature switch: If either switch opens, the pilot valve and the main valve are shut down. The blower continues to run for 30 seconds attempting to close the circuit. The gas control LED flashes 3 times with 3 second pause.

Flame Sensor: If flame is lost, the pilot and main valves are shutdown. The blower runs for 15 seconds. The gas control attempts to re-light the pilot 4 times. If unsuccessful, the blower is shutdown, and the gas control proceeds to a 5 minute lockout. The gas control re-attempts to light the pilot starting at Normal Heating Sequence #2.

9. Thermostat Satisfies: Gas control LED flashes once every 4 seconds.

10. Burner Off.

11. Blower post-purge (15 seconds).

Abnormal Operation

1. Flammable Vapor Sensor Fault:

A) If the resistance is greater than 70,000 ohms: The gas control immediately turns off all outputs. The gas control waits and monitors resistance for 30 seconds. If the resistance is greater than 65,000 ohms after 30 seconds, the gas control proceeds to verify resistive delay for 2 minutes and flashes 7 times then 1 time with a three second pause. This process is repeated 5 times until the control either returns to normal operation or proceeds to flammable vapor lockout.

Sequence of Operation

Abnormal Operation (cont'd)

B) If the resistance is below 3000 ohms: The gas control immediately turns off all outputs and proceeds to flash 8 times then 1 time with a three second pause. The error self clears if the resistance returns to normal range for at least 15 seconds.

2. Temperature Sensor Fault:

A) Temperature Sensor Open Circuit: The gas control immediately turns off all outputs and proceeds to flash 8 times then 3 times with a three second pause. The error self clears if the fault clears for at least 15 seconds.

B) Thermal well sensors not reading the same temperature within $\pm 5.5^{\circ}\text{F}$: The gas control immediately turns off all outputs and proceeds to flash 8 times then 3 times with three second pause. The error self clears if the fault clears for at least 15 seconds.

C) Water Temperature in excess of ECO (Energy Cut Off) Limit: The gas control immediately turns off the pilot and main valves. The gas control LED proceeds to flash 4 times with a 3 second pause.

To reset the gas control, rotate the setpoint knob to the minimum setting for at least 6 seconds before returning to desired temperature setting.

3. Pressure Switch/Blower Temperature Fault:

A) Pressure switch closed at start of call for heat: The gas control waits 4 seconds then, proceeds to flash 2 times with a 3 second pause. The gas control waits 2 minutes and then turns on the blower for 30 seconds. The blower turns off after 30 seconds and the control waits for the pressure switch to open. Any time the pressure switch opens, the blower turns on (or stays on) and the control proceeds to wait for the pressure switch to close.

Abnormal Operation (cont'd)

- B) Pressure switch or blower temperature switch failed to close: The gas control runs the blower for 30 seconds waiting for the pressure switch and/or the blower temperature switch to close. If either switch does not close in 30 seconds, the blower turns off and the control flashes 3 times with a 3 second pause. The gas control waits 2 minutes before turning on the blower for another 30 seconds to see the circuit close. This cycle repeats as long as there is a call for heat or until the circuit closes.
 - C) Pressure switch or blower temperature switch opens during operation: The gas control turns off the pilot and main valve, runs the blower for 15 seconds (inter-purge) waiting for the pressure switch and/or the blower temperature switch to close. If either switch fails to close, the gas control proceeds as described in 3b above. If the circuit closes again by the end of the inter-purge, the recycle counter is incremented, if the recycle count has not reached its limit (4), another trial for ignition begins. If the recycle count has been reached, the gas control turns off the blower and flashes 6 times, then 2 times with a 3 second pause. The gas control waits 5 minutes before repeating ignition sequence.
4. Trial for Ignition Fault:
- A) Pressure switch opens during trial: The gas control turns off the igniter and pilot valve. The gas control proceeds as described in 3b above. If the pressure switch closes within 30 seconds the gas control will continue with a trial for ignition starting at blower pre-purge.
 - B) Flame Not Sensed: The gas control energizes the spark igniter attempting to light the pilot and prove flame. If flame is not sensed within 90 seconds, the spark igniter turns off, the pilot valve is closed. The gas control LED flashes 6 times then 1 time with 3 second pause. The control waits 5 minutes before repeating the ignition sequence.

Sequence of Operation

Abnormal Operation (cont'd)

5. Flame Sensing Fault:

A) Flame Lost During Run: The gas control turns off the pilot and main valves and runs the blower for 15 seconds (inter-purge) The gas control increments the recycle count, if the recycle count has not reached its limit (4), another trial for ignition begins. If the recycle count has been reached, the gas control LED flashes 6 times then 3 times with a 3 second pause. The gas control waits 5 minutes before repeating the ignition sequence.

B) Flame Sensed Out of Sequence: The gas control only looks for pilot flame when the blower is running. If flame is present when the pilot valve is not open, the gas control proceeds to wait for flame loss and flashes 5 times with 3 second pause. This continues until flame is lost, once the flame signal is lost, the control flashes 6 times then 4 times with a 3 second pause. The control waits 5 minutes before repeating the ignition sequence.

Troubleshooting

Observe the green LED on the water heater gas control. Error codes are displayed with a 3 second pause before repeating. Once the error code is known, check and repair the water heater, as recommended in the table below.

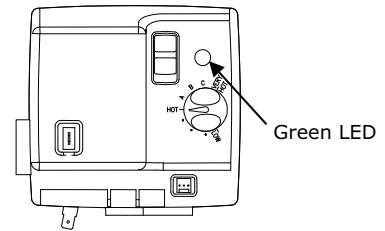

LED Status	Control Status	Probable Cause	Service Procedure
None (LED not on or flashing)	No electrical power	Control power switch in "OFF" position. Supply voltage interrupted.	Turn Power On
One short flash every four seconds	Stand-by mode, Thermostat is satisfied (no faults)	Temperature demand is satisfied (no call for heat)	Normal operation
Alternates bright and dim (heartbeat)	Thermostat calling for heat (no fault)	Tank temperature below setpoint of thermostat	Normal operation
Short flash once every second	Weak pilot signal on last call for heat	1. Unstable pilot 2. Pilot tube blocked or restricted 3. Oxidation build-up on pilot electrode 4. Wire damage to pilot assembly or bad connection at gas control	1. See Burner Inspection on page 20 2-4. See Pilot Inspection, Testing and Replacement on page 22
Two flashes, three second pause	Pressure switch not working-closed position	1. Pressure switch tubing kinked or blocked 2. Blocked pressure tap on switch or blower 3. Faulty pressure switch	1-3. See Pressure Switch Testing on page 25
Three flashes, three second pause	Pressure switch or blower temperature switch not working-open position	1. Vent blockage or improper vent configuration 2. Pressure switch tubing kinked or blocked 3. Faulty pressure switch 4. Blower not spinning up to speed 5. Blower temperature or exhaust temperature too high 6. Faulty blower temperature switch	1. Check vent or vent tables 2-3. See Pressure Switch Testing on page 25 4. See Blower Testing on page 28 5-6. See blower Temperature Switch Testing on page 31
Four flashes, three second pause	Excessive tank temperature, system must be reset	1. Thermal well sensor out of calibration 2. Faulty gas control	1. Test Gas Control & Thermal Well 2. Replace gas control if necessary
Five flashes, three second pause	False pilot flame present	Pilot valve stuck in open position	Replace gas control

Troubleshooting

LED Status	Control Status	Probable Cause	Service Procedure
Six flashes, one flash, three second pause (Soft Lockout)	Failed to light pilot, system resets after (5) minutes	<ol style="list-style-type: none"> 1. Unstable pilot 2. Pilot tube block or restricted 3. Oxidation build-up on pilot electrode 4. Wire damage to pilot assembly or bad connection at gas valve 	<ol style="list-style-type: none"> 1. See Burner Inspection on page 20 2-4. See Pilot Inspection, Testing and Replacement on page 22
Six flashes, two flashes, three second pause (Soft Lockout)	Pressure switch or blower temperature switch opened during burner operation. System resets after (5) minutes	<ol style="list-style-type: none"> 1. Vent blockage or improper vent configuration 2. Pressure switch tubing kinked or blocked 3. Faulty pressure switch 4. Vent termination being affected by wind 5. Blower not spinning up to speed 6. Blower temperature or exhaust temperature too high 7. Faulty blower temperature switch 	<ol style="list-style-type: none"> 1. Check vent or vent tables 2-3. See Pressure Switch Testing on page 25 4. Refer to venting section of installation manual 5. See Blower Testing on page 28 6-7. See Blower Temperature Switch Testing on page 31
Six flashes, three flashes, three second pause (Soft Lockout)	Pilot flame extinguished, system auto resets after (5) minutes	<ol style="list-style-type: none"> 1. Unstable pilot 2. Pilot tube block or restricted 3. Oxidation build-up on pilot electrode 4. Wire damage to pilot assembly or bad connection at gas control 5. Insufficient combustion air 6. Insufficient gas pressure 	<ol style="list-style-type: none"> 1. See Burner Inspection on page 20 2-4. See Pilot Inspection, Testing and Replacement on page 22 5. Refer to Installation & Operation Manual
Six flashes, four flashes, three second pause	Undesired false pilot flame sensed, system auto resets	Pilot valve stuck in open position	Replace gas control
Seven flashes, three second pause	Flammable vapor sensor or resettable thermal switch fault detected, see warning label	<ol style="list-style-type: none"> 1. Flammable vapor present 2. Flammable vapor sensor exposed to excessive moisture 3. Flammable vapor sensor exposed to extreme ambient temperature 4. Resettable thermal switch open 	See Flammable Vapor Sensor Testing on page 40
Eight flashes, one flash, three second pause	Flammable vapor sensor out of specification, possible short	<ol style="list-style-type: none"> 1. Flammable vapor sensor out of specification; verify Flammable Vapor Sensor (FVS) resistance is not below 25 kΩ. 2. Possible short in flammable vapor sensor or resettable thermal switch wiring 	See Flammable Vapor Sensor Testing on page 40

Troubleshooting

LED Status	Control Status	Probable Cause	Service Procedure
Eight flashes, three flashes, three second pause	Thermal well sensor damaged or unplugged or gas control electronics fault detected	<ol style="list-style-type: none"> 1. Damage to thermal well wires 2. Thermal well sensor resistance out of range 3. Replace thermal well 4. Verify control is not wet or physically damaged 5. Reset control on/off switch 6. Replace gas control if 8-3 error persists 	See Thermal Well Testing on page 34
Eight flashes, four flashes, three second pause	Gas control fault detected	<ol style="list-style-type: none"> 1. Verify control is not wet or physically damaged 2. Reset control on/off switch 3. Replace gas control if 8-4 error persists 	<ol style="list-style-type: none"> 1. Replace gas control if wet or physically damaged 2. Cycle power 3. Replace gas control

Burner Maintenance

Burner Inspection

At periodic intervals (every 6 months), a visual inspection should be made of the pilot and main burner for proper operation and to assure no debris is accumulating. The pilot flame should be stable. Some causes for an unstable pilot flame are:

- a) Gas pressure is out of specification.
- b) Pilot flame not fully engulfing spark/flame sensor.

The main burner should light smoothly from the pilot and burn with a blue flame with a minimum of yellow tips. After 5 minutes of operation the burner screen will become radiant and the flame will soften and turn orange. If the burner screen does not become radiant after 5 minutes of operation it must be cleaned (see burner cleaning procedure below).

Burner Cleaning Procedure

Step 1. Move the gas control power switch to the "OFF" position.

Gas control power switch



Step 2. Unplug the water heater from the wall outlet.

TTW (water heater) power cord

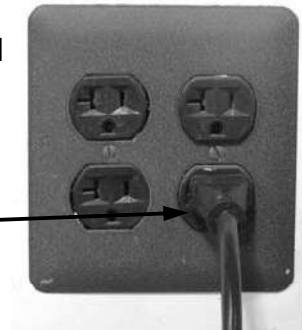

Step 3. Turn off the gas supply to the water heater.

Step 4. Remove the outer door.

Outer door

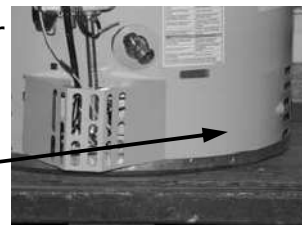

Burner Maintenance

Burner Cleaning Procedure (cont'd)

Step 5. Remove the (4) 1/4" hex drive screws holding the right side inner door in place.

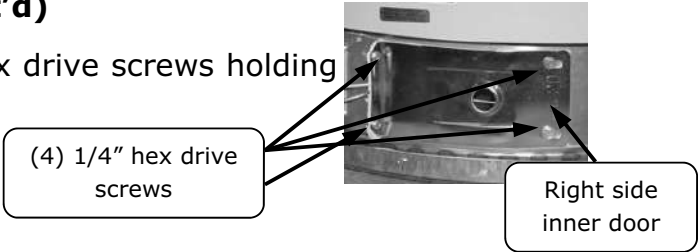

Step 6. Remove the (3) 1/4" hex drive screws holding the left side burner door in place.

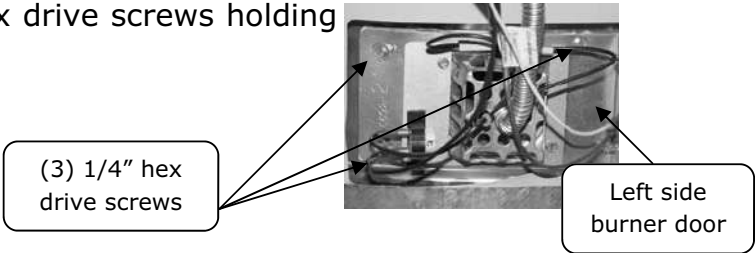

Step 7. Disconnect the pilot tube using a 7/16" wrench and the main burner feedline with a 3/4" wrench from the gas control.

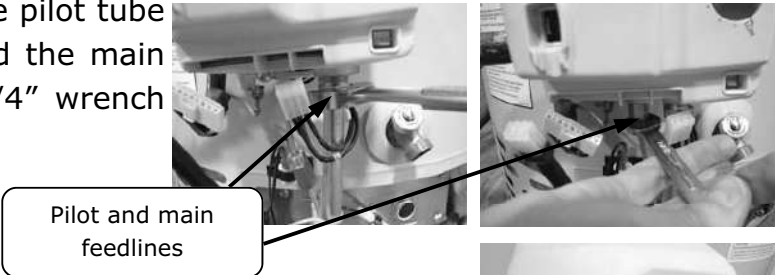

Step 8. Disconnect the spark igniter/flame sensor wire from gas control.

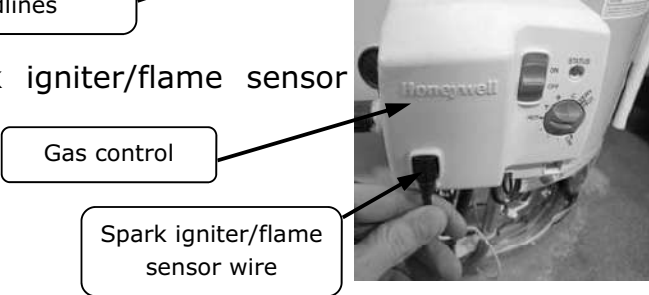

Step 9. Remove the burner assembly from the combustion chamber.

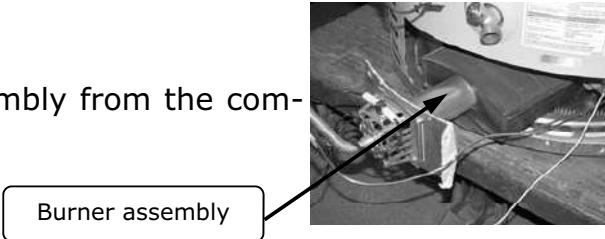

Step 10. Remove manifold mount from burner inner door by removing (2) 1/4" hex drive screws.

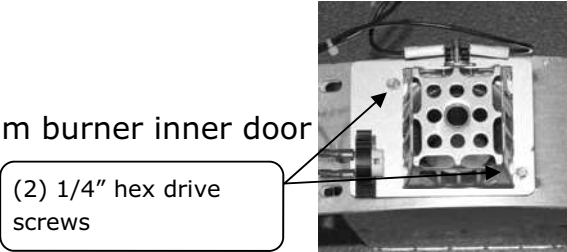

Pilot Maintenance

Burner Cleaning Procedure (cont'd)

Step 11. Thoroughly inspect burner screen and burner venturi and remove any loose debris accumulation. Inspect burner screen for any openings larger than the normal screen openings.

Burner screen

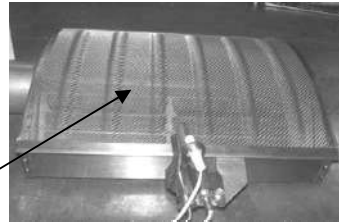

Step 12. Use compressed air and/or a vacuum to remove any scale or other debris accumulation from the burner screen and venturi.

Burner venturi

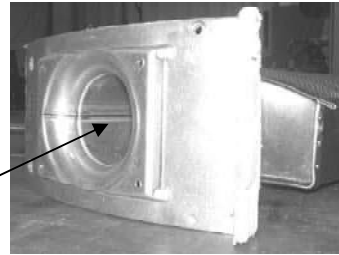

Step 13. Disconnect (unscrew) manifold mount from feed line. Use a stiff brush, compressed air and/or vacuum to remove any debris build up from the manifold mount.

Manifold mount

Feedline

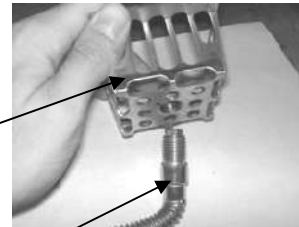

Step 14. Remove main burner orifice from feed line (3/8" wrench). Inspect and clean if necessary.

Main burner orifice

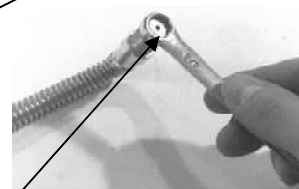

Step 15. Reassemble the burner assembly and reinstall into the water heater. Restore gas supply and check for gas leaks.

Step 16. To resume operation, follow the instructions located on the water heater lighting instruction label. Or, use the lighting instructions located in the water heater installation and operating manual.

Pilot Inspection, Testing and Replacement

Step 1. Move the gas control power switch to the "OFF" position

Gas control power switch

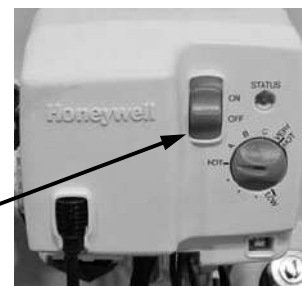

Pilot Inspection, Testing and Replacement (cont'd)

Step 2. Unplug the water heater from the wall outlet.

TTW (water heater) power cord

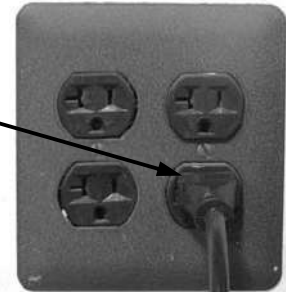

Step 3. Turn off the gas supply to the water heater.

Step 4. Remove the outer door.

Outer Door

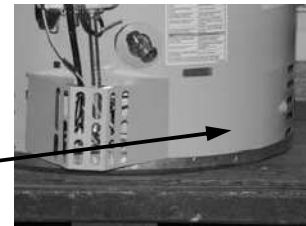

Step 5. Remove the (4) 1/4" hex drive screws holding the right side inner door in place.

(4) 1/4" hex drive screws

Right side inner door

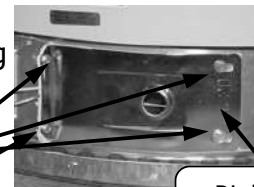

Step 6. Disconnect the pilot tube using a 7/16" wrench and the main burner feedline with a 3/4" wrench from the gas control.

Pilot and main feedlines

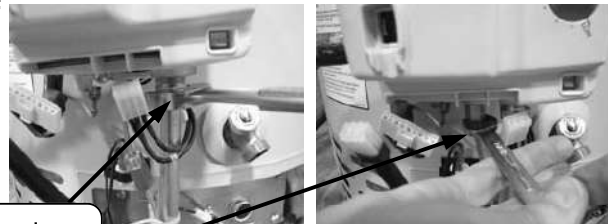

Step 7. Disconnect the spark igniter/flame sensor wire from gas control.

Gas control

Spark igniter/flame sensor wire



Pilot Maintenance

Pilot Inspection, Testing and Replacement (cont'd)

Step 8. Remove the burner assembly from the combustion chamber.

Burner assembly



Step 9. Remove the pilot assembly from the main feedline using a 1/4" nut driver.

Pilot assembly

1/4" nut driver

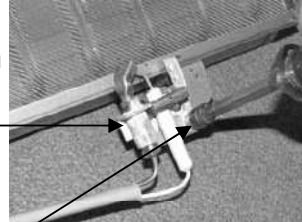

Step 10. Visually inspect the spark igniter/flame sense wire for damage. Replace the pilot assembly, if damage is found.

Step 11. With a multi-meter set to the ohms setting, check continuity through the spark igniter/flame sense wire. Replace the pilot, if there is no continuity.

Multi-meter

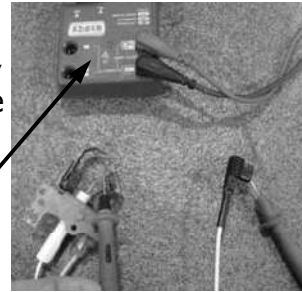

Step 12. Visually inspect the spark igniter/flame sense electrode for deterioration. Replace the pilot assembly, if necessary. The electrode should not be in contact with pilot hood. If it is in contact with the pilot hood, carefully adjust electrode to a gap distance of 3/32" from the pilot hood.

Step 13. Visually inspect the spark igniter/flame sense electrode for oxidation build up. Carefully clean any oxidation using very fine emery cloth.

Step 14. Visually inspect the pilot tubing for kinks or cracks. If damage is found, replace the pilot assembly.

Pilot Inspection, Testing and Replacement (cont'd)

Step 15. Inspect the pilot tubing and pilot orifice for blockages:

- a) Remove ferrule nut from the bottom of the pilot assembly using a 7/16" wrench.
- b) Remove the pilot tube and pilot orifice.
- c) Inspect the pilot tubing and pilot orifice for blockages. Clean or replace, as necessary.

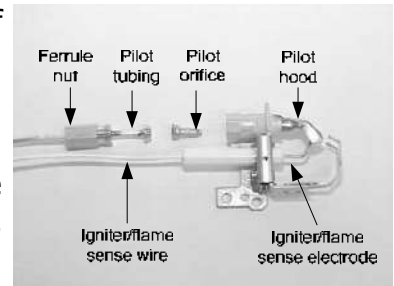

Step 16. Reassemble the pilot assembly and install it on the main burner. Reinstall the burner assembly into the combustion chamber. Restore the gas supply and check for gas leaks.

Step 17. To resume operation, follow the instructions located on the water heater lighting instruction label. Or, use the lighting instructions located in the water heater installation and operating manual.

Pressure Switch Testing

WARNING

115 volt potential exposure. Use caution making voltage checks to avoid personal injury.

Step 1. Move the gas control power switch to the "OFF" position.

Step 2. Remove the three screws (Phillips screw driver) from the control access cover on the blower assembly and remove cover (see photo 1).

Step 3. Carefully remove pres-

Gas control power switch

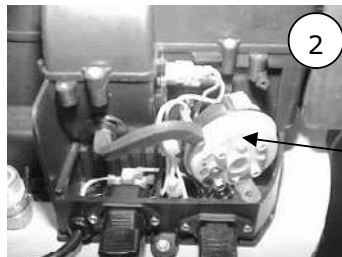
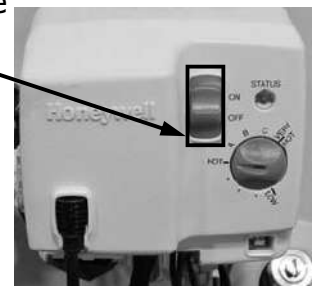

Pressure Switch

Pressure Switch Testing

Pressure Switch Testing (cont'd)

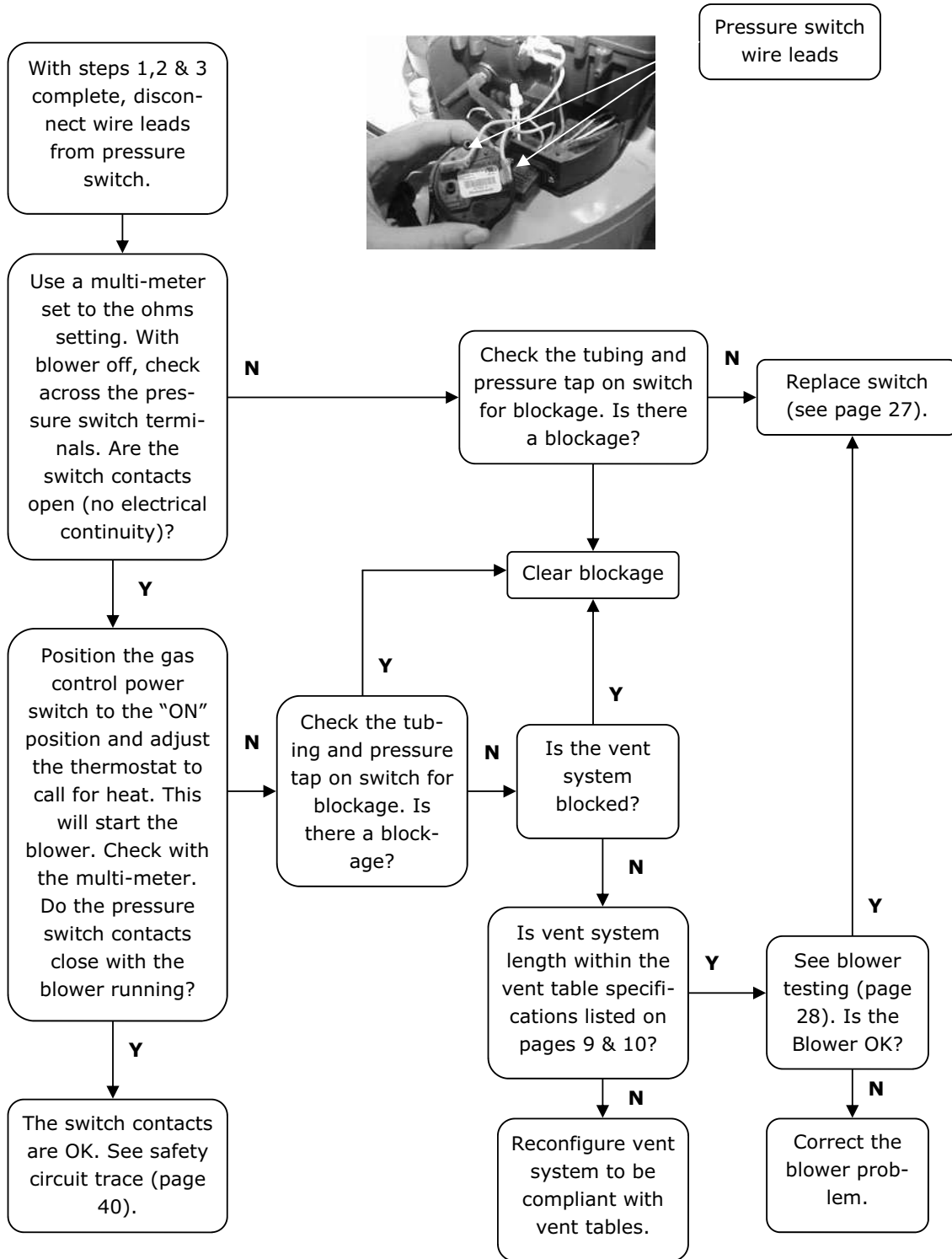

Pressure Switch Replacement

Pressure Switch Replacement



WARNING

115 volt potential exposure. Use caution making voltage checks to avoid personal injury.

Step 1. Move the gas control power switch to the "OFF" position.

Gas control power switch



Step 2. Remove the three screws (Phillips screw driver) from the control access cover on the blower assembly and remove cover.

Control access cover

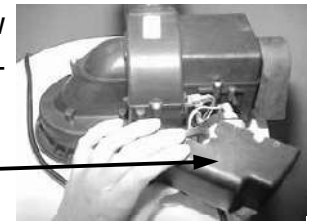

Step 3. Carefully remove pressure switch from blower housing.

Control access cover



Slide pressure switch in direction of arrow while tilting slightly away from blower housing

Step 4. Disconnect tubing from the pressure switch.

Pressure switch tubing

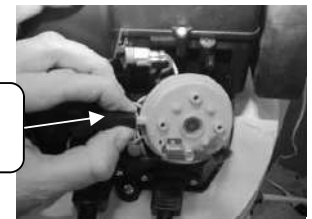

Blower Testing

Step 5. Disconnect yellow wires from the pressure switch.

Yellow pressure switch wires

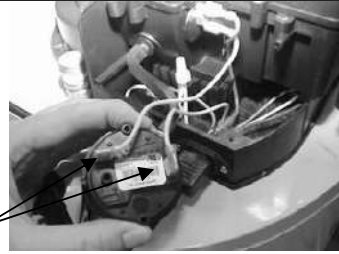

Step 6. Reconnect wires from step 5 to new pressure switch.

Step 7. Reconnect tubing to new pressure switch.

Step 8. Carefully position pressure switch into blower housing.

Step 9. Position gas control power switch to the "ON" position and verify proper heater operation.

Step 10. Replace control access cover from step 2.

Blower Testing

WARNING

115 volt potential exposure. Use caution making voltage checks to avoid personal injury.

Step 1. Move the gas control power switch to the "ON" position and adjust control to call for heat.

Gas control power switch

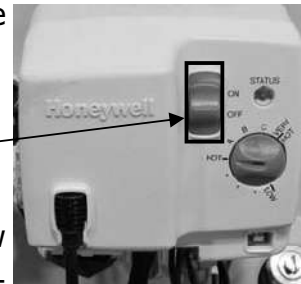

Step 2. Remove the three screws (Phillips screw driver) from the control access cover on the blower assembly and remove cover.

Control access cover



Blower Replacement

Blower Removal

Step 1. Move the gas control power switch to the "OFF" position.

Gas control power switch



Step 2. Unplug the water heater from the wall outlet.

TTW (water heater) power cord

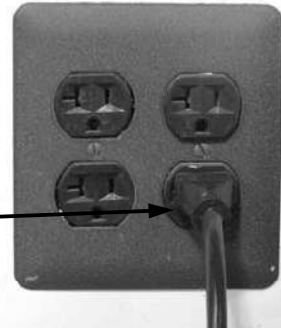

Step 3. Disconnect vent system from exhaust adapter on top of blower.

Remove exhaust adapter and retain for use on new blower

Step 4. Remove exhaust adapter from blower (blade screw driver) and retain for use on new blower.

Blower mounting screws

Step 5. Remove dilution air clip from air intake boot and retain for use on new blower.

Step 6. Unplug cord sets from blower.

Blower cord sets

Step 7. Remove the three blower mounting screws (1/4" nut driver).

Remove dilution air clip and retain for use on new blower

Step 8. Remove blower with gasket from water heater.

Blower Installation

Step 9. Clean any debris from jacket head of water heater

Locating pins on blower flange

Step 10. Set new blower with gasket in place using locating pins on blower flange to line up with location holes in jacket head. Be sure not to damage gasket.

Pin location holes in jacket head

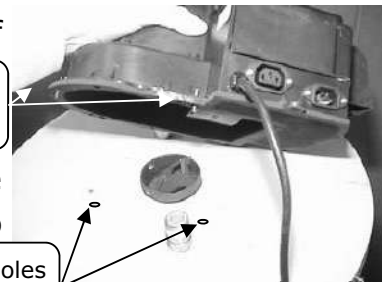

Blower Temperature Switch Testing

Blower Installation (cont'd)

- Step 11. Secure blower in place using mounting screws from step 7.
- Step 12. Reinstall exhaust adapter from step 4.
- Step 13. Reinstall dilution air clip from step 5.
- Step 14. Reconnect vent system to exhaust adapter.
- Step 15. Reconnect cords from step 6.
- Step 16. Position gas control power switch to the "ON" position.
- Step 17. Verify proper blower operation.

Blower Temperature Switch Testing



WARNING

115 volt potential exposure. Use caution making voltage checks to avoid personal injury.

- Step 1. Move the gas control power switch to the "OFF" position.

Gas control power switch

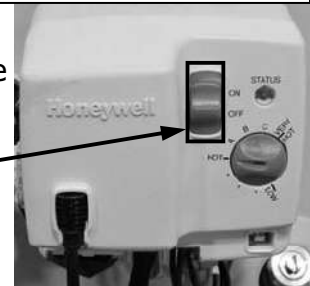

- Step 2. Remove the three screws (Phillips screw driver) from control access cover on blower and remove cover.

Control access cover

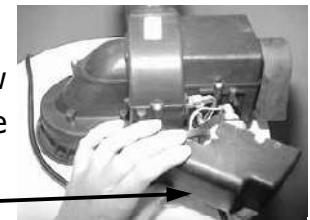

- Step 3. Locate the blower temperature switch.

Blower temperature switch location

Air mixing inlet

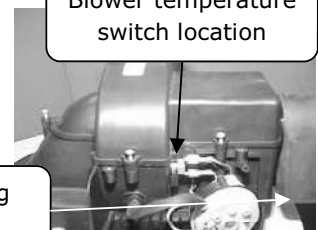

Blower Temperature Switch Testing

Blower Temperature Switch Testing (cont'd)

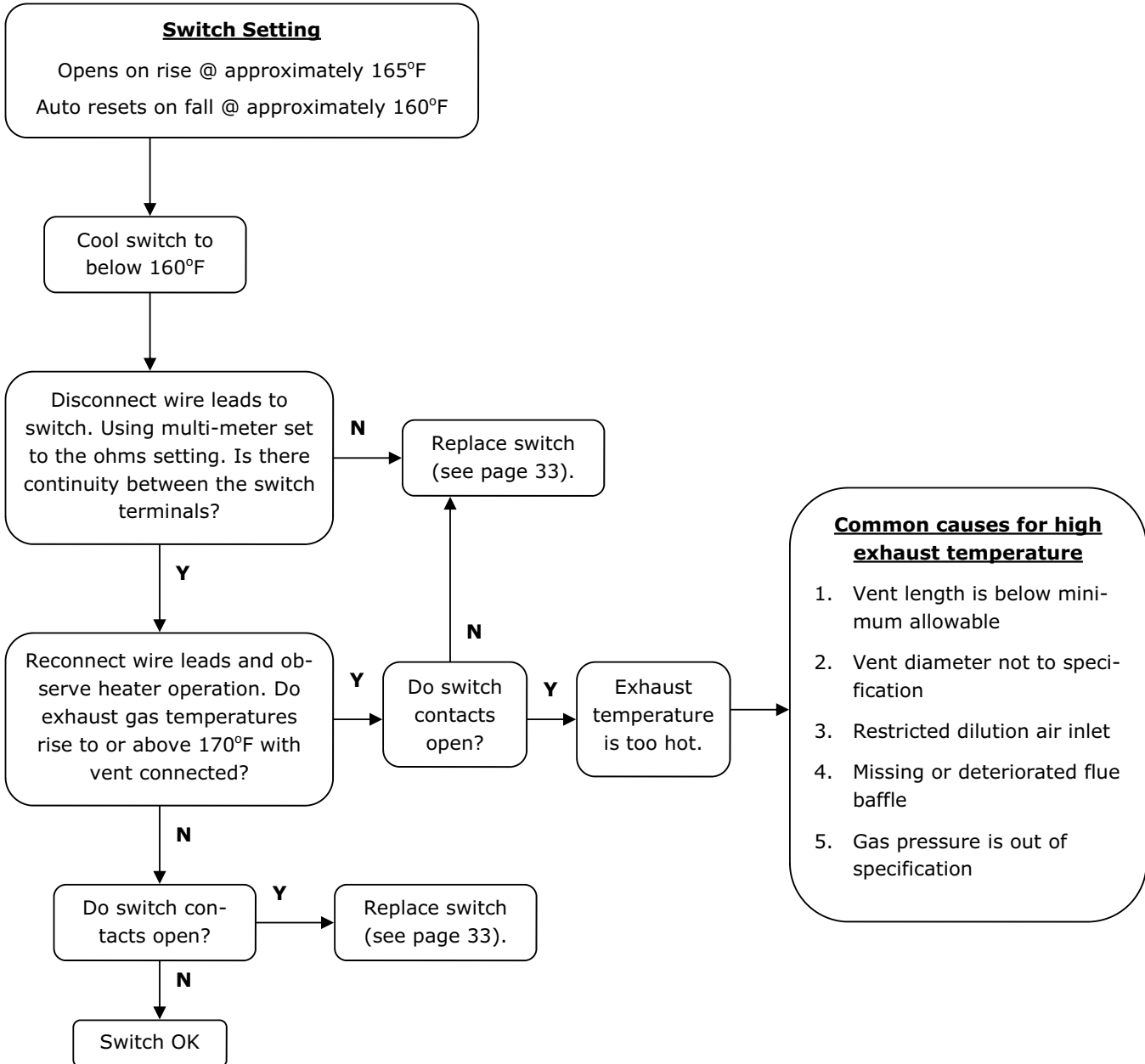

Blower Temperature Switch Replacement

Blower Temperature Switch Replacement



WARNING

115 volt potential exposure. Use caution making voltage checks to avoid personal injury.

Step 1. Move the gas control power switch to the "OFF" position.

Gas control power switch



Step 2. Remove the three screws (Phillips screw driver) from the control access cover on the blower assembly and remove cover.

Control access cover

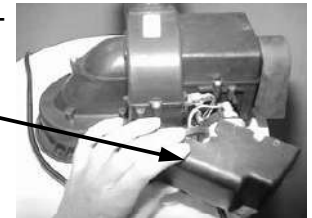

Step 3. Locate blower temperature switch.

Step 4. Disconnect red and yellow wire leads from the switch.

Blower temperature switch location

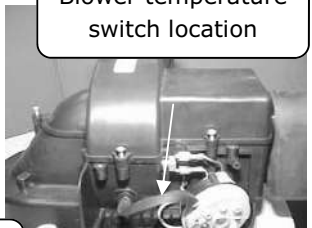

Step 5. With an appropriate tool such as side cutters, snip the retaining lug from the blower housing to allow removal of temperature switch.

Snip retaining lug from blower housing



Step 6. Remove switch from blower housing.

Step 7. Install new switch. Be sure switch is properly seated in mounting area.

Step 8. Reconnect red and yellow wires to new switch. Wires are interchangeable with either terminal.

Step 9. Position the gas control power switch to the "ON" position and verify proper heater operation.

Step 10. Replace control access cover from step 2.

Thermal Well Testing

Thermal Well Testing



CAUTION

Do not use standard multi-meter probes for this testing. Doing so will damage the connector. Use special pin type electronic probes or small diameter wire pins inserted into connector.

Follow the procedure, below, if the water heater gas control has gone into a ECO lock-out (4 flash, 3 second pause). Reset the gas control by rotating the setpoint knob to the minimum setting for at least 6 seconds before returning to the desired water temperature setting.

Step 1. Unplug the thermal well connector from the gas control.

Thermal well connector



Step 2. With a multi-meter set to the ohms setting, measure the resistance between the middle and right side wires.

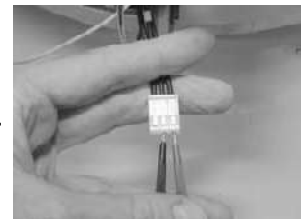

Step 3. With a multi-meter set to the ohms setting, measure the resistance between the middle and left side wires.

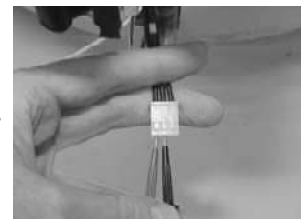

Determine Tank Temperature

Thermal Well Testing (cont'd)

Determine the correct resistance values using the Determine the Water Temperature Inside the Tank procedure on page 23. If the values are correct, replace the gas control, otherwise replace the thermal well.

Determine Water Temperature Inside Tank

WARNING

Stored water may be HOT when performing the following steps in this procedure. Take necessary precaution to prevent personal injury.

Note: It is important to understand once the resistance for the thermal well is determined using the Thermal Well Testing Procedure on page 21, water flow through the water heater should not occur. Prior to performing the steps below, turn off the cold water supply to the water heater. This will prevent cold water flow into the tank affecting the resistance value of thermal well.

Step 1. Move the gas control power switch to the "OFF" position.

Gas control power switch



Step 2. Draw approximately 4 gallons of water from the drain valve into a container and discard. Draw an additional gallon and immediately measure the water temperature using an accurate thermometer. It may be necessary to open a hot water faucet to allow heater to drain.

Step 3. Using the chart on page 23, determine the correct resistance value for the water temperature from Step 2.

Example: If temperature of water is 84°F, then the resistance through the sensor would be 8449 (see shaded area). NOTE: Sensor resistance increases as the temperature falls.

Component Disassembly

Sensor Resistance at Various Temperatures

		In Degrees F									
°F	0	1	2	3	4	5	6	7	8	9	
40	26109	25400	24712	24045	23399	22771	22163	21573	21000	20445	
50	19906	19383	18876	18383	17905	17440	16990	16553	16128	15715	
60	15314	14925	14548	14180	13823	13477	13140	12812	12494	12185	
70	11884	11592	11308	11032	10763	10502	10248	10000	9760	9526	
80	9299	9078	8862	8653	8449	8250	8057	7869	7685	7507	
90	7333	7165	7000	6839	6683	6531	6383	6238	6098	5961	
100	5827	5697	5570	5446	5326	5208	5094	4982	4873	4767	
110	4663	4562	4464	4368	4274	4183	4094	4006	3922	3839	
120	3758	3679	3602	3527	3453	3382	3312	3244	3177	3112	
130	3048	2986	2925	2866	2808	2752	2697	2643	2590	2538	
140	2488	2439	2391	2344	2298	2253	2209	2166	2124	2083	
150	2043	2004	1966	1928	1891	1856	1820	1786	1753	1720	
160	1688	1656	1625	1595	1566	1537	1509	1481	1454	1427	
170	1402	1376	1351	1327	1303	1280	1257	1235	1213	1191	
180	1170	1150	1129	1110	1090	1071	1053	1035	1017	999	
190	982	965	949	933	917	901	886	871	857	842	
200	828	814	801	788	775	762	749	737	725	713	

Gas Control & Thermal Well Removal From Water Heater

Step 1. Move the gas control power switch to the "OFF" position.

Gas control power switch



Step 2. Unplug the water heater from the wall outlet.

TTW (water heater) power cord

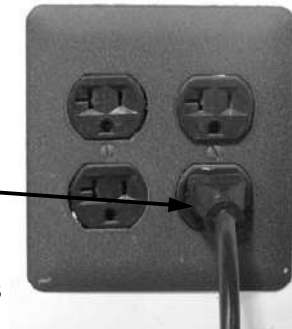

Step 3. Drain the water heater to a point below the gas control level.

Step 4. Turn off the gas supply to the water heater and disconnect the gas piping from the gas control.

Gas Control & Thermal Well Removal From Water Heater (cont'd)

Step 4. Disconnect the pilot tube using a 7/16" wrench and the main burner feedline with a 3/4" wrench from the gas control.



Pilot and main feedlines

Step 5. Disconnect the wire harnesses and spark igniter/flame sense wire from the gas control.

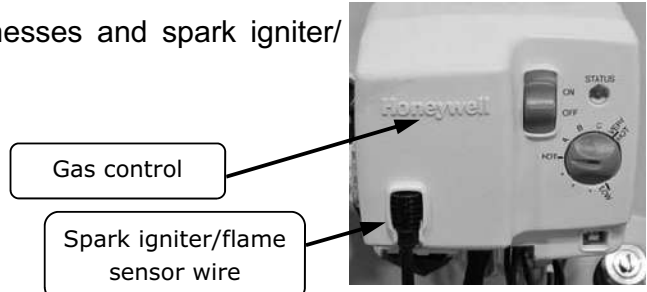

Gas control

Spark igniter/flame sensor wire

Step 6. Remove the gas control & thermal well by rotating the flats of the Thermal Well counter clockwise using a 1-5/16" wrench.

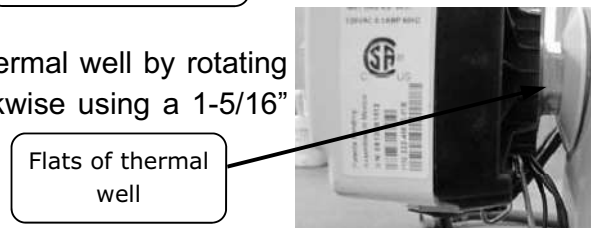

Flats of thermal well

Gas Control Removal From Thermal Well

Following the steps below allows for the removal of the gas control from the thermal well without removing the thermal well from the tank.

Step 1. Move the gas control power switch to the "OFF" position.

Gas control power switch

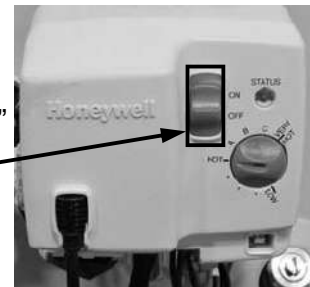

Step 2. Unplug the water heater from the wall outlet.

TTW (water heater) power cord

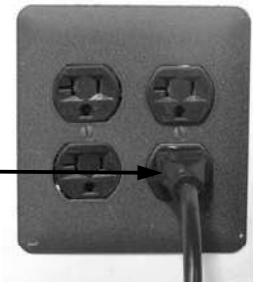

Gas Control Assembly

Gas Control Removal From Thermal Well (cont'd)

Step 3. Turn off the gas supply to the water heater and disconnect the gas piping from the gas control.

Step 4. Disconnect the pilot tube using a 7/16" wrench and the main burner feedline with a 3/4" wrench from the gas control.



Pilot and main feedlines

Step 5. Disconnect the wire harnesses and spark igniter/flame sense wire from the gas control.

Gas control

Spark igniter/flame sensor wire



Step 6. Using the gas control service tool, p/n 239-45991-00, available from your BWC parts supplier, insert the tool into the back of the gas control.

Gas control service tool



Step 7. Pivot the tool towards the water heater, as far as possible. Lift straight up on the gas control. The gas control should move about 1/8". Hold the gas control in position and remove the tool. Lift straight up on the gas control to remove it completely from the thermal well.

Gas Control Assembly to the Thermal Well

Step 1. Install the threaded end of the thermal well into the tank. Be sure the thermal well flange is positioned properly to allow for proper gas control installation. Tighten the thermal well using a 1-5/16" wrench.

Gas Control Assembly to the Thermal Well (cont'd)

Step 2. Route the wire leads back into relief opening.

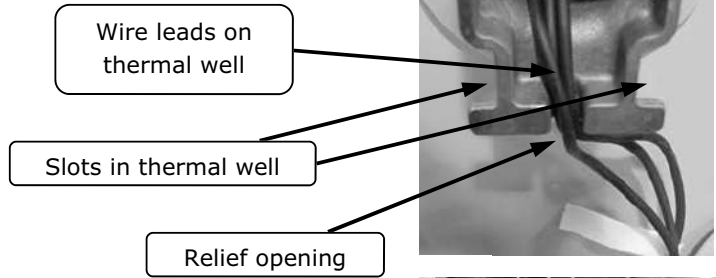

Step 3. Align the slots located on the thermal well flange with the tabs located on the back of the gas control.



Step 4. Carefully push the gas control back onto the thermal well flange as far as possible towards the water heater. Then, slide the gas control down to lock into position.

Step 5. Install the burner assembly and connect the pilot and main feedlines to the gas control using a 7/16" and 3/4" wrench, respectively.

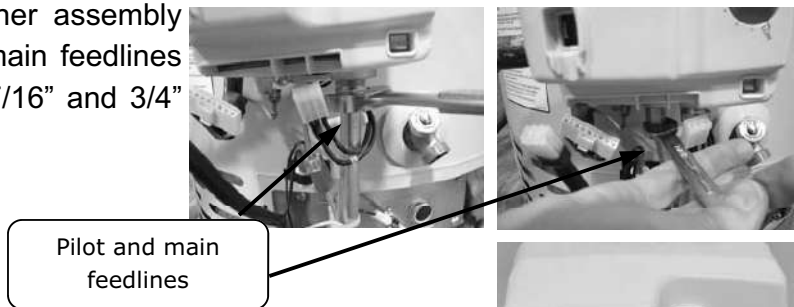

Step 6. Reconnect the wire harnesses to the gas control.



Step 7. Reconnect the gas piping to the gas control. Restore the gas supply and check for gas leaks.

Flammable Vapor Sensor Testing

Gas Control Assembly to the Thermal Well (cont'd)

Step 8. To resume operation, follow the instructions located on the water heater lighting instruction label. Or, use the lighting instructions located in the water heater installation and operating manual.

Flammable Vapor Sensor Testing



Do not use standard multi-meter probes for this testing. Doing so will damage the connector. Use special pin type electronic probes or small diameter wire pins inserted into connector.

Step 1. Move the gas control power switch to the "OFF" position.

Gas control power switch

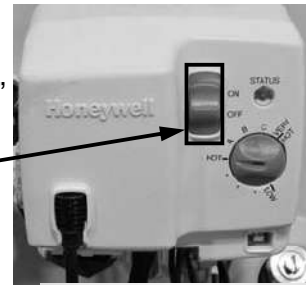

Step 2. Disconnect the flammable vapor sensor harness from the gas control.

Flammable vapor sensor harness



Step 3. Using a multi-meter set to the ohms setting, measure the resistance of the flammable vapor sensor and resettable thermal switch. The resistance must be between 3,000 and 48,000 ohms. If the resistance is out of this range, verify that the resettable thermal switch has not been tripped. If it hasn't, replace the thermal switch.

Flammable vapor sensor harness

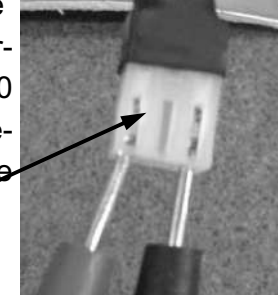

115 VAC Circuit Trace

Step 1. Verify 115VAC and proper polarity are at the wall outlet.

Step 2. With the water heater plugged in and the gas control power switch in the "ON" position verify LED status.

115 VAC Circuit Trace

! WARNING

115 volt potential exposure. Use caution making voltage checks to avoid personal injury.

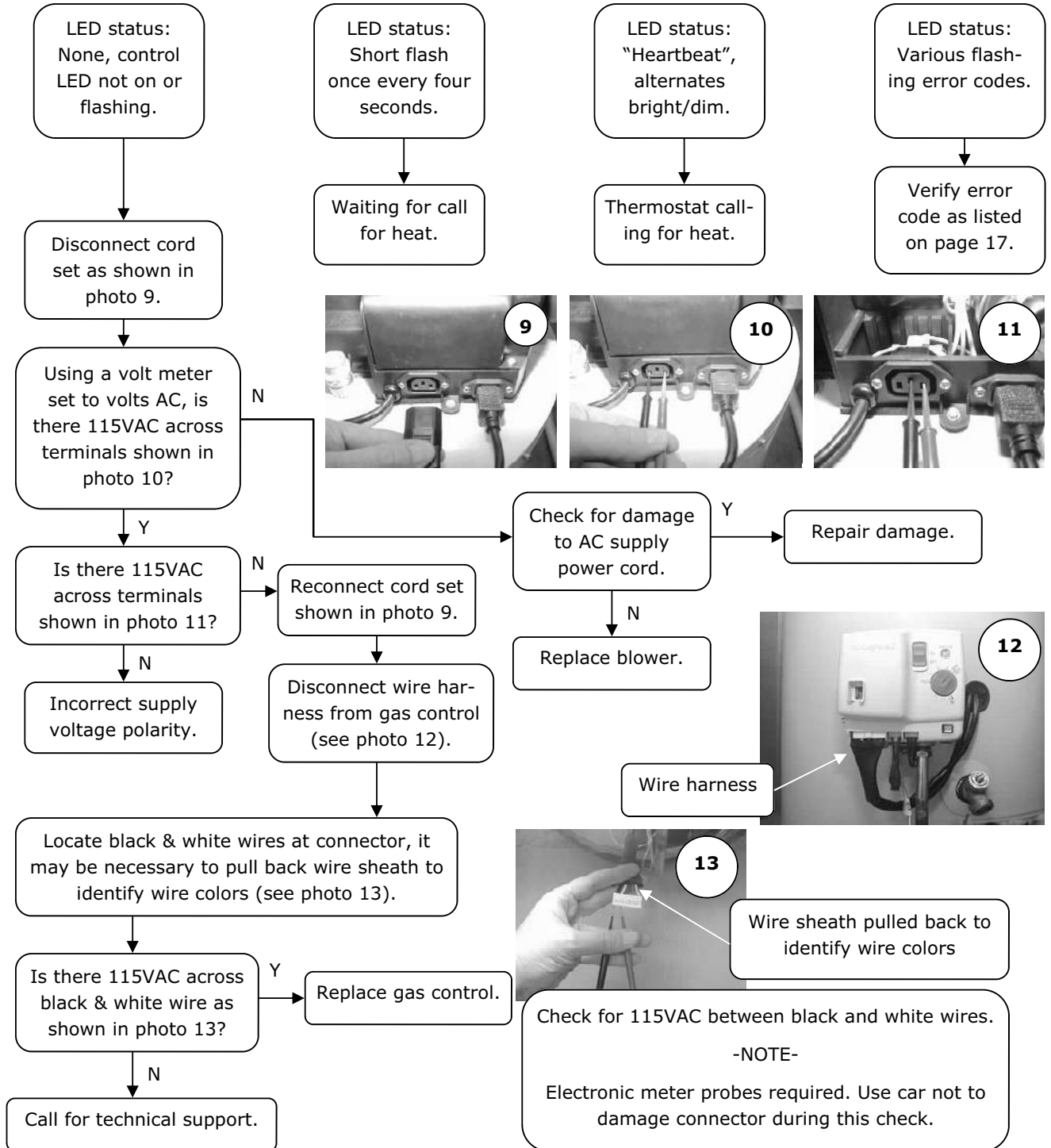

Safety Circuit Voltage Trace

WARNING

115 volt potential exposure. Use caution making voltage checks to avoid personal injury.

Safety Circuit Voltage Trace

Note: This procedure assumes a cold tank.

Step 1. Remove three screws (Phillips screw driver) from control access cover on blower and remove control access cover.

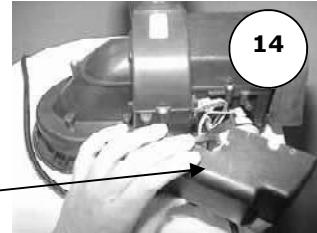

14

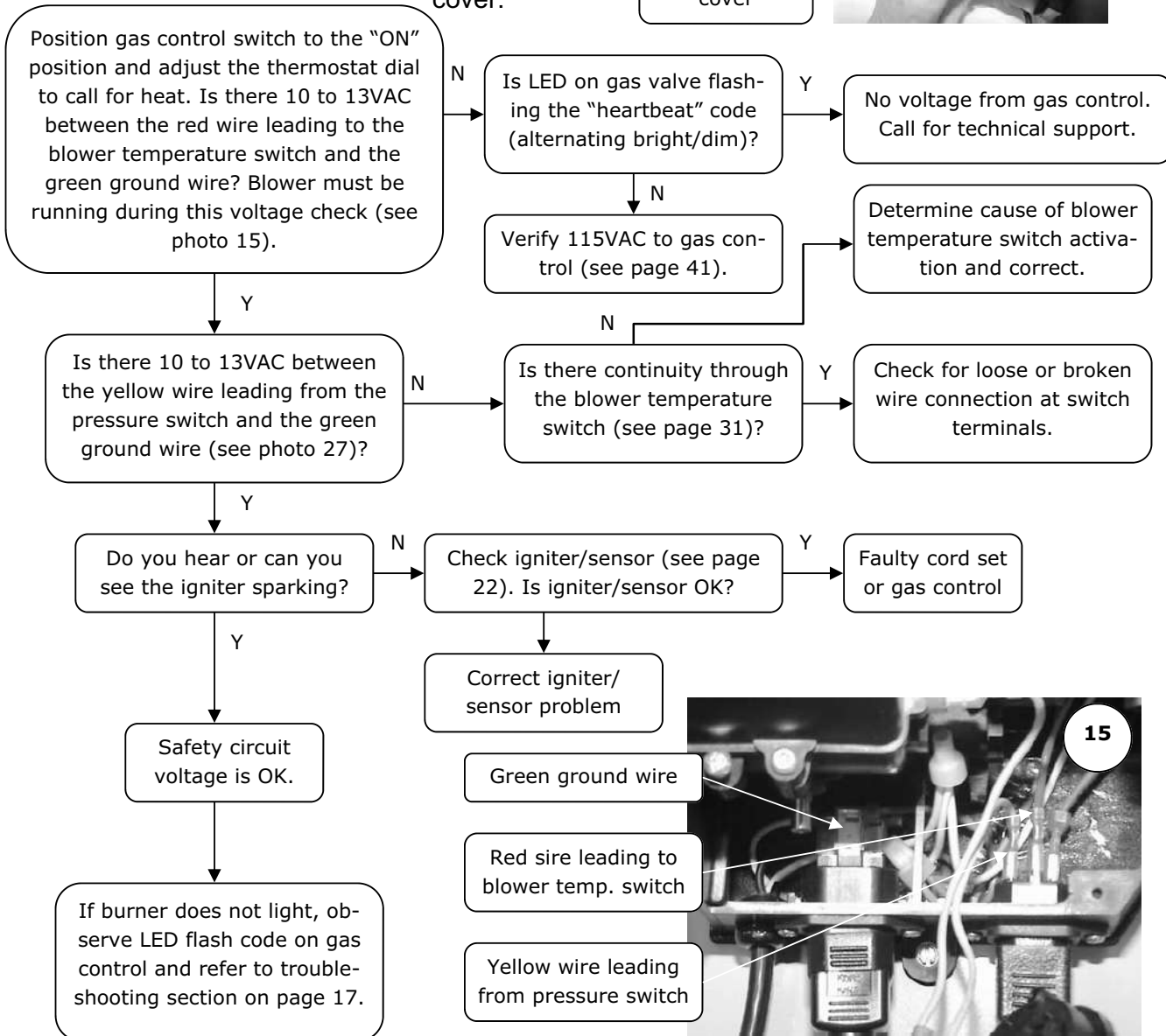

Blower Removal

Remove the Blower to Gain Access to the Flue Baffle

Step 1. Move the gas control switch to the "OFF" position.

Gas control power switch

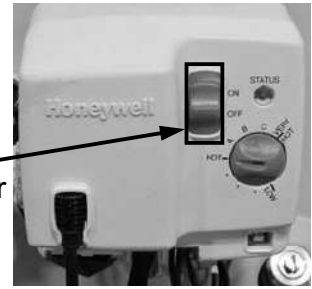

Step 2. Unplug the water heater from the wall outlet.

TTW (water heater) power cord



Step 3. Disconnect the vent system from the exhaust adapter on top of blower.

Exhaust adapter

Blower mounting screws

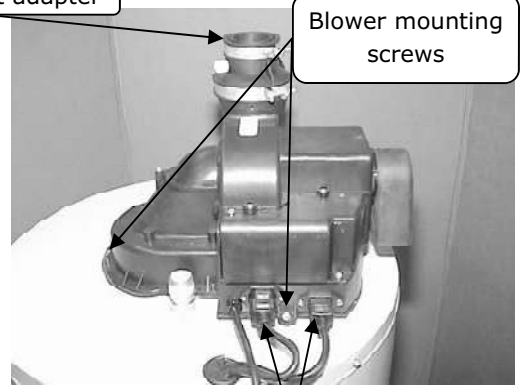

Step 4. Unplug the cord sets from the blower.

Blower cord sets

Step 5. Remove the three blower mounting screws (1/4" nut driver).

Step 6. Remove the blower with gasket from the top of the water heater.

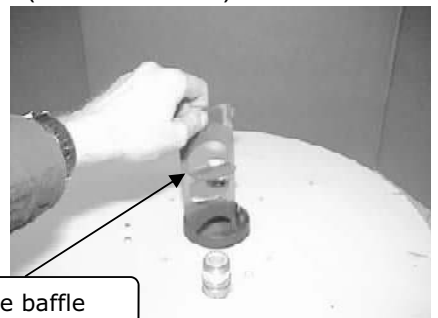

Step 7. Remove the flue baffle from the

Flue baffle

Dip Tube Inspection

water heater.

Remove the Blower to Gain Access to the Flue Baffle (cont'd)

Step 8. Inspect the baffle for deterioration and missing restrictors. Clean any scale or debris build-up. Replace with a new baffle, as necessary.

Step 9. Reinstall the baffle into the flue. Be sure the baffle hanger tab is inserted into the notch locations at the top of the flue.

Step 10. Check the burner to ensure no scale has accumulated during operation. See the Burner Cleaning Procedure on page 20, if accumulation has occurred.

Step 11. Secure the blower in place using the screws from Step 5.

Step 12. Reconnect the vent system to the exhaust adapter.

Step 13. Reconnect the cord sets from Step 4.

Step 14. Plug the water heater into the wall outlet.

Step 15. To resume operation, follow the instructions located on the water heater

WARNING

Water heater components and stored water may be HOT when performing the following steps in this procedure. Take necessary precaution to prevent personal injury.

lighting instruction label. Or, use the lighting instructions located in the water heater installation and operating manual.

Dip Tube Inspection and Replacement

Step 1. Move the gas control power switch to the “OFF” position

Step 2. Unplug the water heater from the wall outlet.

Step 3. Turn off the cold water supply to the water heater. Connect a hose to the drain valve of the water heater and route to an open drain. Open a nearby hot water faucet to vent the water heater for draining. Open the drain valve of water heater and allow the water heater to drain to a point below the inlet connection nipple.

Step 4. Disconnect the inlet nipple from the plumbing system.

Step 5. With an appropriate tool, such as a pipe wrench, remove the inlet nipple/diptube from the water heater. Use caution not to damage pipe threads.

Step 6. Visually inspect the inlet nipple/diptube. The inlet nipple/diptube should

be free of cracks and any blockage. Hydro-jet slots should be open and free of any blockage. Any damage, such as cracks, restriction due to deformation, or unintentional holes are not field repairable and the inlet nipple/diptube must be replaced.

Step 7. Upon completion of the inspection or subsequent replacement, reinstall the inlet nipple/diptube into the water heater. Connect the nipple to the plumbing system, resume water supply to the water heater, and refill the water heater.

Step 8. To resume operation, follow the instructions located on the water heater



WARNING

Water heater components and stored water may be HOT when performing the following steps in this procedure. Take necessary precaution to prevent personal injury.

lighting instruction label. Or, use the lighting instructions located in the water heater installation and operating manual.

Anode Inspection and Replacement

Step 1. Move the gas control power switch to the “OFF” position

Step 2. Unplug the water heater from the wall outlet.

Step 3. Turn off the cold water supply to the water heater. Connect a hose to the drain valve of the water heater and route to an open drain. Open a nearby hot water faucet to vent the water heater for draining. Open the drain valve of water heater and allow the water heater to drain to a point below the outlet connection nipple.

Step 4. Disconnect the outlet nipple from the plumbing system.

Step 5. With an appropriate tool, such as a pipe wrench, remove the outlet nipple/anode from the water heater. Use caution not to damage the pipe threads.

Step 6. Visually inspect the outlet nipple/anode. The outlet nipple/anode should show signs of depletion, which is normal. If depletion is one-half the original anode diameter (approximately 3/4” diameter), replacement is recommended. If any of the steel core of the anode is exposed, replacement is recommended.

Step 7. Upon completion of the inspection or subsequent replacement, reinstall the outlet nipple/anode into the water heater. Connect the nipple to the plumbing system, resume water supply to the water heater, and refill the water heater.

Inner Door Removal

Step 8. To resume operation, follow the instructions located on the water heater lighting instruction label. Or, use the lighting instructions located in the water heater installation and operating manual.

Inner Door Removal Procedure

Gas control power switch



Step 1. Move the gas control power switch to the "OFF" position.

Blower (water heater) power cord

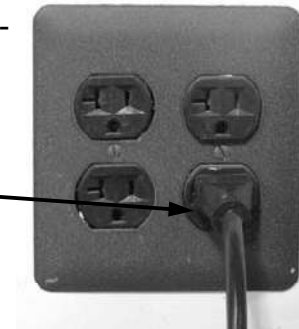

Step 2. Unplug the water heater from the wall outlet.

Outer door

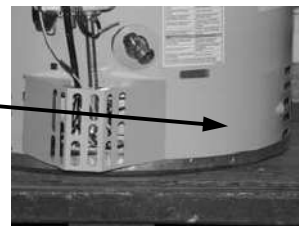

Step 3. Remove the outer door.

(4) 1/4" hex drive screws

Right side inner door

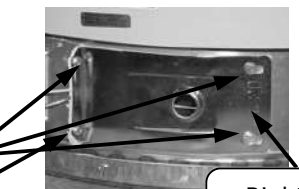

Step 4. Remove (4) 1/4" hex drive screws from the right side inner door.

(3) 1/4" hex drive screws

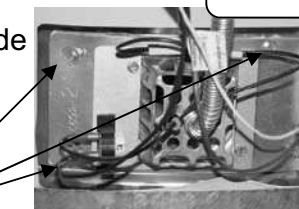

Step 5. Remove (3) 1/4" drive screws from the left side burner door.

Connectors attached to resettable thermal switch

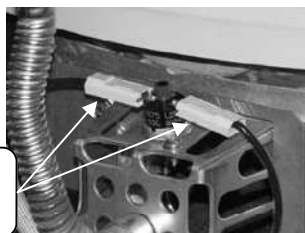

Inner Door Gasket Replacement

Step 6. Remove the connectors attached to the re-settable thermal switch on the manifold mount.

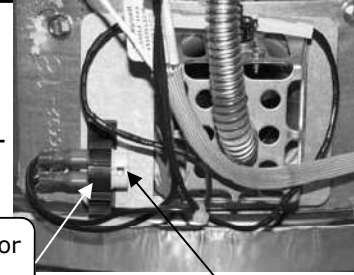

Flammable vapor sensor clip

Flammable vapor sensor

Inner Door Removal Procedure (cont'd)

Step 7. Remove the flammable vapor sensor from the clip by pushing down on the tab to open the clip.

Step 8. Inspect both inner doors for any of the following imperfections: tears, missing material, cracks, dirt or debris, lack of adhesion to the inner door, material left



WARNING

If the information in these instructions is not followed exactly, a fire or explosion may result causing property damage, personal injury, or death.

on combustion chamber, or any other imperfections that will inhibit a proper seal.

If any of the imperfections above are present, replace the inner door gasket following the Inner Door Gasket Replacement Procedure. If not, replacement of the inner door gaskets is not necessary.

Gasket overlap must be as shown $\pm 1/32$

replace the inner

Enlarged view of flange area

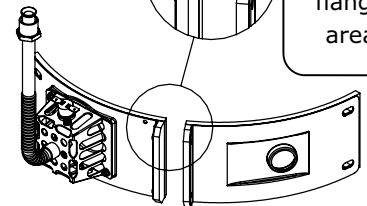

Inner Door Gasket Replacement Procedure

Step 1. Completely remove all gasket and adhesive residue from the right and left side inner doors, as needed.

Recommended pattern for RTV sealant

Step 2.

Using RTV sealant, apply a 1/8" bead to secure

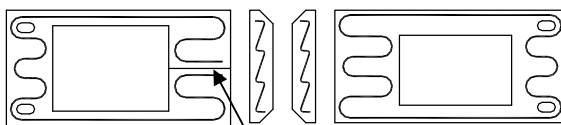

Slice gasket here to slide over burner venturi

Gasket overlap must be as shown $\pm 1/32$

Expanded view

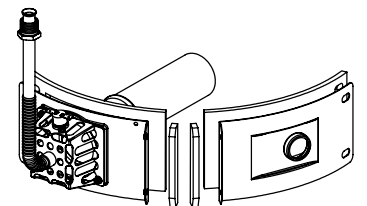

Inner Door Installation

inner door gasket to the inner door sections. Refer to the illustration for proper applica-

WARNING

Stripped fastener connections may allow for an inner door seal breach. A seal breach may result in a fire or explosion, causing property damage, personal injury, or death. Do not over tighten screws. If a fastener connection is stripped, contact the manufacturer listed on the water heater rating plate.

tion. Note the overlap configuration in the flange area of the inner door. Set the flange section first, and this will help to achieve the proper overlap position.

Inner Door Installation with Gasket

Step 1. Clean any residual gasket residue or other debris from the combustion chamber surface before installing the inner door/gasket assembly.

Step 2. Place the left side inner door into position first, being sure to firmly position the concave channel of the inner door around the feedline.

Step 3. Using the 1/4" hex drive screws removed in Step 5 of the Inner Door Removal Procedure on page 32, secure the left side inner door in place. Do not over-tighten the screws.

Step 3. Position the pilot tube and spark igniter wire against the left side inner door flange gasket. Do not route these through the concave channel with the feedline.

Step 4. Firmly place the right side inner door flange against the left side inner door flange.

Step 5. Using the 1/4" hex drive screws removed in Step 4 of the Inner Door Removal Procedure on page 32, secure the two flanges together. Do not over-tighten the screws.

Step 6. Align the right side inner door to the combustion chamber and verify the fastener holes of the combustion chamber are aligned with the right side inner door slotted openings. Verify seal integrity around the combustion chamber opening.

Step 7. Using the 1/4" hex drive screws removed in Step 3 of the Inner Door Removal Procedure on page 32, secure the right side inner door. Do not over-tighten the

screws. Verify that both the left and right side inner doors are properly positioned and sealed against the combustion chamber.

Step 8. Re-install the outer door.

Step 9. To resume operation, follow the instructions located on the water heater lighting instruction label. Or, use the lighting instructions located in the water heater installation and operating manual.

ScreenLok® Flame Arrestor Cleaning Procedure

Step 1. Move the gas control power switch to the “OFF” position and unplug the water heater from the wall outlet.

Step 2. Remove the outer door.

Step 3. Remove the right side inner door per the Inner Door Removal Procedure on page 32.

Step 4. Disconnect the pilot tube using a 7/16” wrench and the main burner feedline with a 3/4” wrench from the gas control.

Step 5. Disconnect the spark igniter/flame sensor wire from gas control.

Step 6. Remove the burner assembly from the combustion chamber.

Step 7. Clean the ScreenLok® flame arrestor using a stiff brush, compressed air, and/or a shop vacuum to remove any scale or other debris accumulation. Using a soft brush, clear jacket openings from any dirt, dust, restrictions, or other obstructions.

Step 8. Remove any debris from the burner assembly following the Burner Cleaning Procedure on page 15.

Step 9. Re-install the burner assembly.

Step 10. Reconnect the main and pilot tubing and spark igniter wire to the gas control.

Step 11. Re-install the inner door per the Inner Door Installation with Gasket Procedure on page 34.

Step 12. To resume operation, follow the instructions located on the water heater lighting instruction label. Or, use the lighting instructions located in the water heater installation and operating manual.

Common Terms

Common Terms

BTU	British Thermal Units
ECO	Energy Cut Off
GPM	Gallons per Minute
Hz	Hertz
KWh	Kilowatts per hour
LED	Light Emitting Diode
NPT	National Pipe Thread
Ohms	Ohms of resistance
PSI	Pounds per Square Inch
RPM	Revolutions per Minute
VAC	Volts Alternating Current
W.C.	Inches of Water Column
°C	Degrees Centigrade
°F	Degrees Fahrenheit

NOTES

Parts List

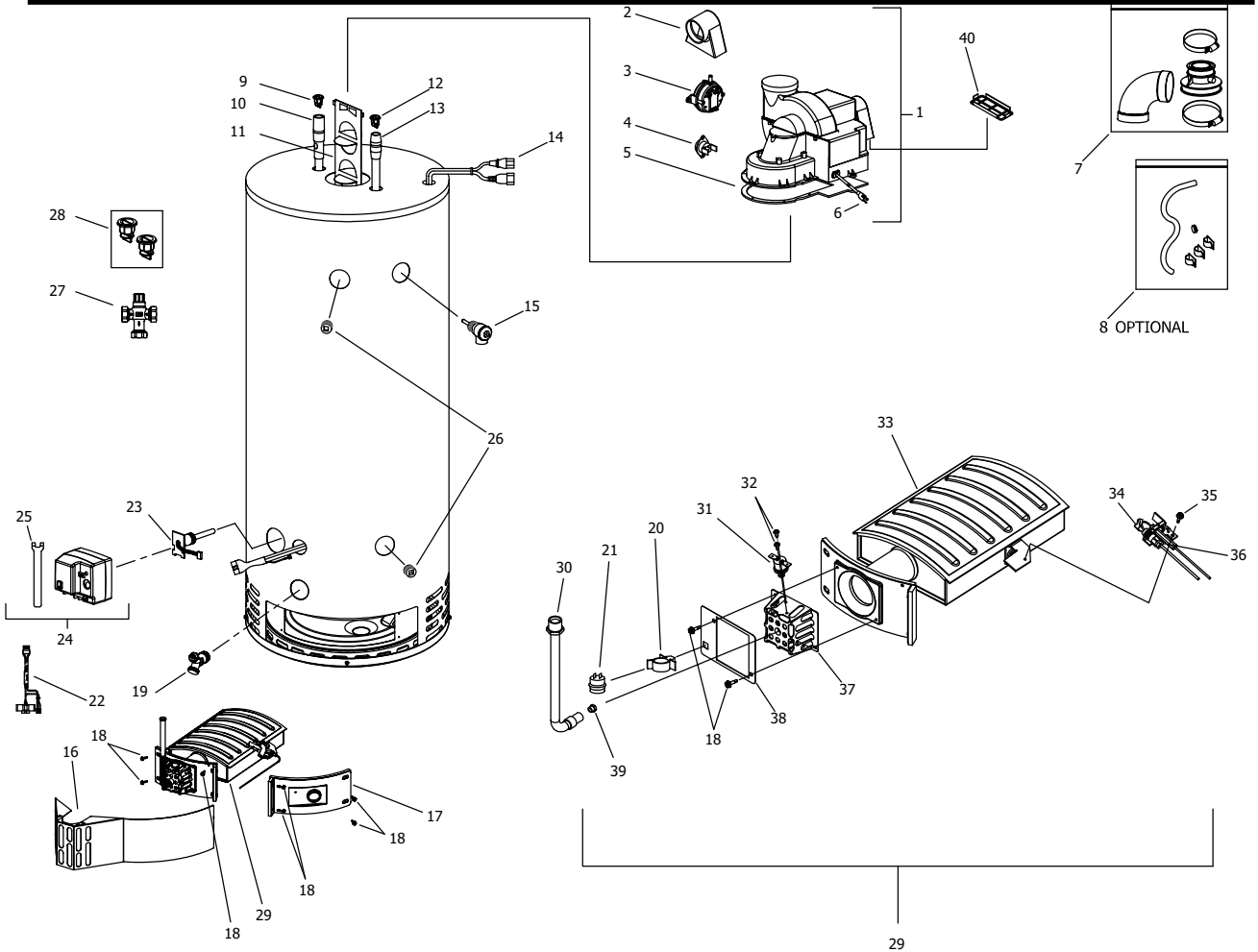

Part Name and Description

- | | | |
|-------------------------------|------------------------------------|---------------------------|
| 1. Blower Complete | 15. T&P Valve | 29. Burner Assembly |
| 2. Air Mixing Inlet | 16. Outer Door | 30. Flexible Gas Feedline |
| 3. Pressure Switch | 17. Right Side Inner Door | 31. Thermal Switch |
| 4. Blower Temperature Switch | 18. Screw #10-12 x 3/4" | 32. Screw #8-18 x 1/2" |
| 5. Blower Gasket | 19. Brass Drain Valve | 33. Burner |
| 6. Blower Power Cord | 20. Flammable Vapor Sensor Clip | 34. Pilot Assembly |
| 7. Vent Adapter w/ Vent Term. | 21. Flammable Vapor Sensor | 35. Screw #8-18 x 1/2" |
| 8. Condensate Hose Kit | 22. Flammable Vapor Sensor Harness | 36. Pilot Orifice |
| 9. Heat Trap Outlet | 23. Thermowell | 37. Manifold Mount |
| 10. Hot Water Outlet Anode | 24. Gas Control | 38. FVIR Sensor Plate |
| 11. Flue Baffle | 25. Gas Control Service Tool | 39. Orifice |
| 12. Heat Trap Inlet | 26. 3/4" NPT Pipe Plug | 40. Dilution Air Clip |
| 13. Inlet Dip Tube | 27. ASSE Approved Mixing Valve | |
| 14. Wire Harness | 28. Kit—Heat Trap Insert | |



BRADFORD WHITE[®]

W A T E R H E A T E R S

Ambler, PA

For U.S. and Canada field service,
contact your professional installer or
local Bradford White sales representative.

Sales/800-523-2931
Fax/215-641-1670
Parts Fax/215-641-2180

Technical Support/800-334-3393
Fax/269-795-1089

Warranty/800-531-2111
Fax/269-795-1089

International:
Telephone/215-641-9400
Telefax/215-641-9750



BRADFORD WHITE-CANADA[®] INC.

Mississauga, ON

Sales/866-690-0961
905-238-0100

Fax/905-238-0105

Technical Support/800-334-3393

Email

parts@bradfordwhite.com
techserv@bradfordwhite.com

www.bradfordwhite.com